

OPERATING INSTRUCTIONS



TYPE 1309-A

OSCILLATOR

GENERAL RADIO COMPANY

B

INSTRUCTION MANUAL

TYPE 1309-A

OSCILLATOR

Form No. 1309-0100-B

ID 1227

July, 1966

Copyright 1962 by General Radio Company
West Concord, Massachusetts, USA

GENERAL RADIO COMPANY
WEST CONCORD, MASSACHUSETTS, USA

TABLE OF CONTENTS

Section 1. INTRODUCTION	1
1.1 Purpose	1
1.2 Description	1
1.3 Controls and Connectors	1
1.4 Accessories Supplied	3
Section 2. INSTALLATION	4
2.1 Environment	4
2.2 Rack Mounting	4
2.3 Power Connection	6
Section 3. OPERATING PROCEDURE	7
3.1 Normal Operation	7
3.2 Precise Adjustments	7
3.3 Output Connection	8
3.4 Characteristics	10
3.5 Square-Wave Output	12
3.6 Synchronization Jack	14
Section 4. APPLICATIONS	20
4.1 General	20
4.2 Slaved Oscillators	20
4.3 Waveform Synthesizer	20
4.4 Accurate Frequency Source with Clean, High, Shortable Output	21
4.5 Tracking, Narrow-Band Filter	23
4.6 Amplitude-Modulated Oscillator	25
4.7 Output Sync	26
Section 5. PRINCIPLES OF OPERATION	27
5.1 General	27
5.2 The Wien Bridge Oscillator	27
5.3 The Oscillator Amplifier	28
5.4 The Square-Wave Generating Circuit	29
5.5 The Power Supply	30
Section 6. SERVICE AND MAINTENANCE	31
6.1 Warranty	31
6.2 Service	31
6.3 Access to Components	31
6.4 Minimum Performance Specifications	32
6.5 Trouble-Shooting Notes	33
6.6 Amplifier Open-Loop Testing	34
6.7 Calibration Procedure	35
PARTS LIST	43-44
APPENDIX	47

SPECIFICATIONS

FREQUENCY

Range: 10 Hz to 100 kHz in four decade ranges.
Control: Continuously adjustable main dial covers range in 1 turn, vernier in $4\frac{1}{4}$ turns.

Accuracy: $\pm 2\%$.

Synchronization: An external reference signal can be introduced through phone jack to phase-lock oscillator. One-volt input provides $\pm 3\%$ locking range. Frequency dial can be used for phase adjustment.

OUTPUT

Sine Wave

Power: 10 mW into 600- Ω load.

Voltage: 5.0 V $\pm 5\%$ open circuit after warmup.

Impedance: 600 Ω . One terminal grounded.

Control: Minimum of 20-dB, continuously adjustable and 60-dB step attenuator (20 ± 0.2 dB per step). Also, a zero-volts output position with 600- Ω output impedance maintained.

Distortion: Less than 0.05% from 200 Hz to 10 kHz, increasing to less than 0.25% at 10 Hz and 100 kHz open circuit or 600 Ω .

Frequency Characteristic: $\pm 2\%$ over whole frequency range for loads of 600 Ω or greater.

Hum: Less than 50 μ V regardless of attenuator setting. (0.001% of full output.)

Synchronization: High-impedance (12 k Ω), constant amplitude output of approximately 1.5 volts for use with external counter, for triggering an oscilloscope, or for synchronizing other oscillators.

Square Wave

Voltage: Greater than +5 V, peak-to-peak, open-circuit. Dc-coupled output.

Impedance: 600 Ω .

Rise Time: Under 100 ns into 50 Ω . Typically 40 ns at full output.

Control: Minimum of 20 dB continuously adjustable attenuator only.

Symmetry: $\pm 2\%$ over whole frequency range.

GENERAL

Terminals: Two Type 938 Binding Posts, one grounded.

Accessories Supplied: Type CAP-22 Power Cord, spare fuses.

Accessories Available: Type 1560-P95 Adaptor Cable (telephone plug to Type 274-M Double Plug) for connection to synchronizing jack, relay-rack adaptor set.

Power Required: 100 to 125 V, 200 to 250 V, 50 to 400 Hz, 6 W.

Mounting: Convertible-bench cabinet.

Dimensions: Width $8\frac{1}{4}$, height 6, depth $8\frac{1}{8}$ inches (210 by 155 by 210 mm), over-all.

Net Weight: $6\frac{3}{4}$ lb (3.1 kg).

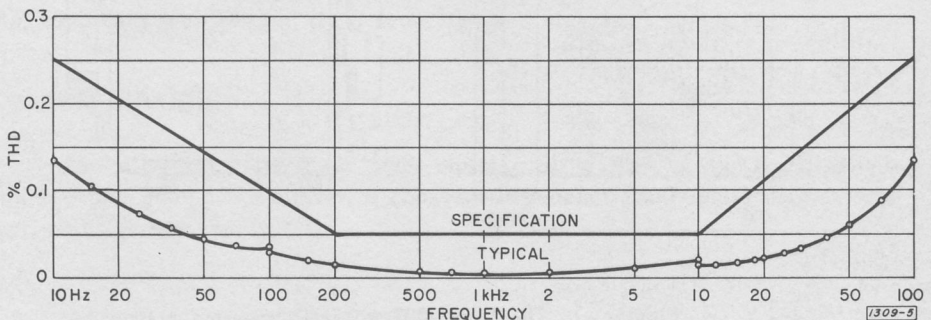

Typical harmonic distortion vs frequency of
Type 1309 sine-wave output.

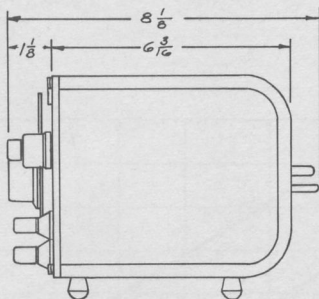
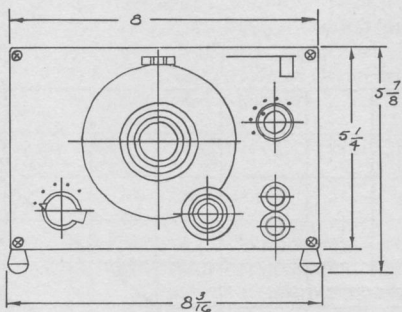

Figure 1-1. The Type 1309-A Oscillator.

SECTION 1**INTRODUCTION****1.1 PURPOSE.**

The Type 1309 Oscillator is a general-purpose source of sine and square waves for laboratory or production use. It features a wide audio frequency range; an accurate output attenuator; low distortion, hum, and noise; high stability and accuracy; rapid-transition, highly symmetrical square waves; plus a synchronizing feature which allows such varied uses as filtering, leveling, frequency multiplying, jitter reducing, and slaving.

1.2 DESCRIPTION.

The all-solid state Type 1309 consists of a Wien bridge oscillator, a square-wave generating circuit, a constant-impedance (600 ohms) step attenuator, and a power supply.

1.3 CONTROLS AND CONNECTORS.

The controls and connectors on the Type 1309 Oscillator are listed in Table 1-1.



TABLE 1-1
CONTROLS AND CONNECTORS

Reference (Figure 1-2)	Name	Type	Function
1	EXT SYNC	Input/output telephone jack.	For introducing a synchronizing or phase-locking signal from an external source or for providing a synchronizing signal, independent of the output level, to an oscilloscope, counter, or another oscillator.
2	FREQUENCY	Five-position rotary switch.	Combination power switch and frequency range switch.
3	FREQUENCY	Continuously adjustable dial.	Used with FREQUENCY range switch to set output frequency.
4	FREQUENCY	Continuously adjustable vernier.	Fine frequency control (4:25:1) for FREQUENCY dial.
5	OUTPUT (larger concentric switch)	Six-position rotary switch.	A 60-dB (20 dB per step) step attenuator and output signal selector. "0V" position removes oscillator output but maintains 600 Ω output impedance for noise measurements.
6	OUTPUT (smaller concentric control)	Continuous rotary control.	A constant-impedance bridged-T attenuator which sets output level over a 20-dB range between the steps selected by the OUTPUT switch.
7	OUTPUT 600 Ω	$\frac{3}{4}$ -inch-spaced binding post pair.	Lower terminal grounded to chassis. (Refer to paragraph 3.3 for information on ungrounded operation.)
(Not shown)	Power input (on rear panel)	Three-terminal male connector.	For connection to power line.
(Not shown)	LINE switch	Slide switch.	Selects transformer connections for input voltages as indicated by the associated legend.



Figure 1-2. Controls and Connectors on the Type 1309.

1.4 ACCESSORIES SUPPLIED.

The accessories supplied with the Type 1309 Oscillator are listed in Table 1-2.

TABLE 1-2 ACCESSORIES	
<i>Item</i>	<i>Part Number</i>
Instruction book	1309-0100
Power cord, 3-wire	4200-9622
Fuses (2), 0.25 A for 115-V operation or: 0.125 A for 230-V operation	5330-0700 5330-0450

For a description of supplementary equipment available for use with the Type 1309, refer to the Appendix.



SECTION 2

INSTALLATION

2.1 ENVIRONMENT.

The Type 1309 is designed to operate in locations with ambient temperatures from 0° to 50° C and to be stored in locations with ambient temperatures from -40 to +70° C.

As with all low-frequency, variable-capacitance, RC oscillators, the oscillator circuit in the Type 1309 operates at impedance levels of over 1000 megohms. Consequently, circuit operation, especially frequency accuracy on the lower ranges, may be affected under conditions of very high humidity. These effects may be minimized by allowing the instrument a warmup period long enough to allow internally generated heat to reduce the humidity within the instrument.

2.2 RACK MOUNTING.

2.2.1 RELAY-RACK ADAPTOR SETS.

The Type 1309 Oscillator can be rack-mounted, alone or with another 8- by 5 1/4-inch convertible-bench instrument, by means of the appropriate adaptor set listed below. The adaptor panels are finished in charcoal-gray crackle paint to match the front panel of the instrument and come complete with the necessary hardware to mount to the instruments and to the rack. For instructions on grounding the rack-mounted Type 1309, refer to paragraph 3.3.

TABLE 2-1. RELAY-RACK ADAPTOR SETS

Type	Description	Catalog Number
	Relay Rack Adaptor Set used to rackmount the Type 1309 alone.	0480-9638
	Relay Rack Adaptor Set used to rackmount the Type 1309 with a Type 1232, 1311, or 1396.	0480-9636

2.2.2 ATTACHMENT OF ADAPTOR SETS. (Figure 2-1).

- a. Remove the rubber feet, if necessary, to clear an instrument mounted below.
- b. Remove the screws that secure the front panel to the aluminum end frames.
- c. Remove the spacers between the front panel and the end frames.

If two instruments are to be mounted side-by-side, join them as follows:

- d. On one instrument, install clips with the front-panel screws removed earlier and install the nut plates with the foot screws removed earlier.
- e. Secure the two instruments together with front-panel screws through the remaining hole in each clip and with a foot screw through the remaining hole in the nut plate.

Note that the instruments can be *bench-mounted* side-by-side in this manner:

Simply do not remove the two feet from each outside end frame and do not install the adaptor plates.

- f. Install two clips on each adaptor plate with the wing screws, lockwashers, and nuts supplied.
- g. Attach the adaptor plates to the instrument with the front-panel screws removed earlier.
- h. Mount the assembly in the rack with the 10-32 screws supplied.

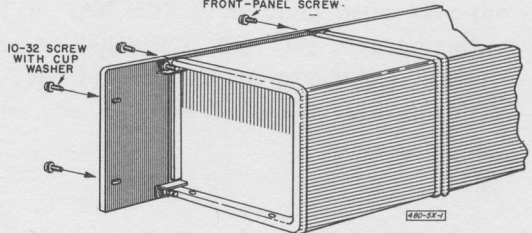
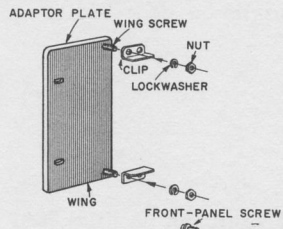
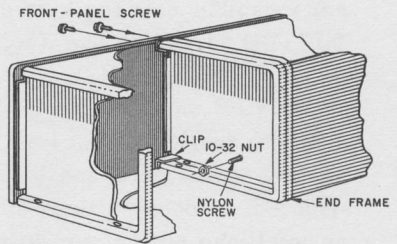
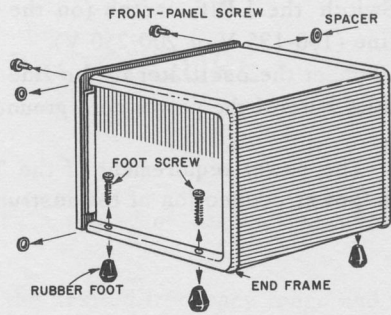

Figure 2-1. Rack mounting the Type 1309 Oscillator.



2.3 POWER CONNECTION.

Connect the Type 1309 to a source of ac power as follows:

- a. Switch the LINE switch (on the back panel) to the voltage of the power line (100-125 V or 200-250 V).
- b. Connect the oscillator to the line via the 3-wire power cord supplied. The third wire of the power cord grounds the instrument frame.

The power requirement of the Type 1309 is 6 watts. For a discussion of the power connection of the instrument as it affects hum, refer to paragraph 3.3.

SECTION 3**OPERATING PROCEDURE****3.1 NORMAL OPERATION.**

To use the Type 1309 Oscillator as a source of internally generated sine or square waves:

- a. Set the FREQUENCY range switch to the desired frequency range and the FREQUENCY dial to the desired frequency.
- b. Selection of the output signal:
 - (1) For sine-wave output, set the OUTPUT switch to one of the center four positions (the number corresponding to a position indicates the maximum voltage attainable at that position), and adjust the OUTPUT control for the exact voltage required.
 - (2) For square-wave output, set the OUTPUT switch in the fully clockwise position and adjust the OUTPUT control for the voltage required.
 - (3) For no output with 600-ohms output impedance maintained, set the OUTPUT switch in the 0V position. This position enables the operator to avoid the transients associated with turning the oscillator on and off and makes zero output possible with no disturbance of the OUTPUT control.

3.2 PRECISE ADJUSTMENTS.**3.2.1 FREQUENCY.**

To set the frequency of the Type 1309 with an accuracy better than the $\pm 2\%$ accuracy obtainable with the FREQUENCY dial, use of a frequency counter such as the General Radio Type 1150 Digital Frequency Meter is recommended. The interconnections for operating the Type 1309 with the Type 1150 are shown in Figure 3-1.

3.2.2 VOLTAGE.

To set accurately the output voltage between the calibrated steps of the OUTPUT attenuator, use of a voltmeter such as the General Radio Type 1806 Electronic Voltmeter is recommended. The interconnections for operating the Type 1309 with the Type 1806 are shown in Figure 3-1.

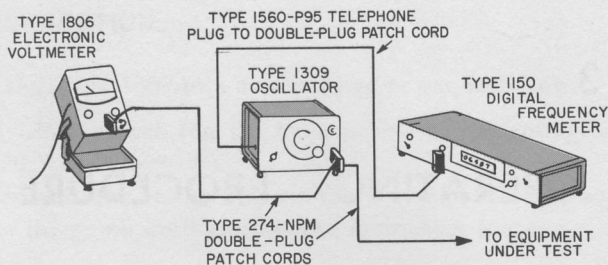

Figure 3-1. Interconnections for operating the Type 1309 with auxiliary instruments.

3.3 OUTPUT CONNECTION.

The full oscillator output is available through the front-panel OUTPUT terminals. The lower terminal, although insulated from the panel at the binding post, is internally connected to the circuit ground of the oscillator which is in turn connected to the chassis. The chassis is normally connected to the power line ground through the 3-wire power cord.

Hum and extraneous signal pickup due to ground loops may occur when the oscillator is used with other ac-line-operated equipment. These signals can be of considerable magnitude compared to the low levels available from the oscillator's attenuator.

Figure 3-2 shows a ground loop that is formed when the 1309 is bench mounted with another line-operated device and both use 3-wire power line connections. If there is 60-Hz ground current flowing through both sides of the loop, it can cause a voltage drop in the signal lead ground which appears in the input of the device under test.

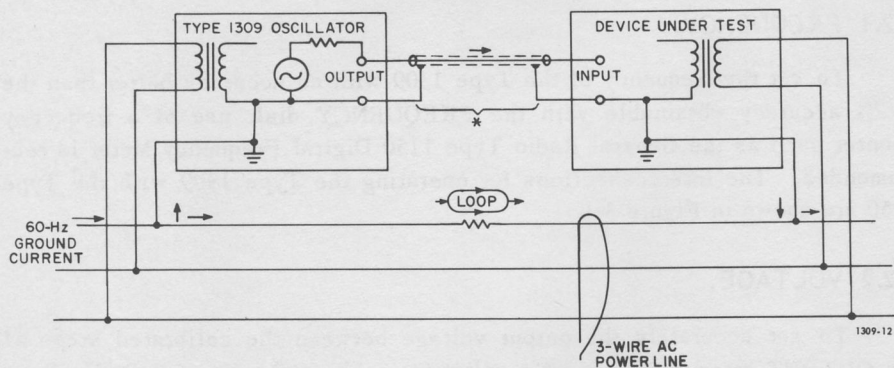

Figure 3-2. A Ground loop. (*60-Hz voltage due to ground current and signal wire shield resistance).

When the Type 1309 is used as a bench instrument, the current can usually be sufficiently reduced by operating one of the devices on a two-wire power cord (see Figure 3-3), which opens the loop.

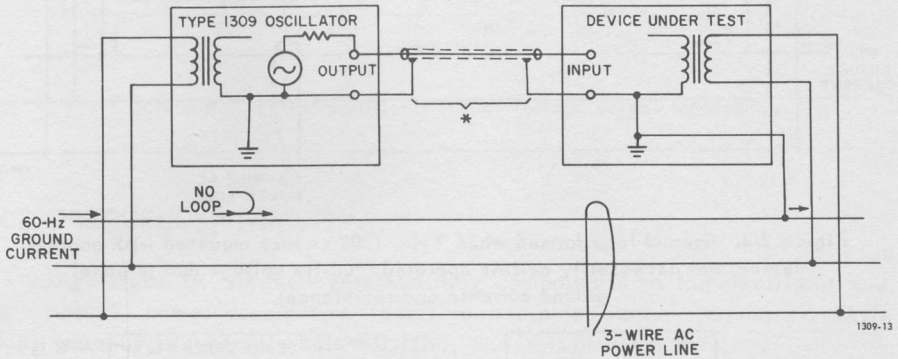

Figure 3-3. Operating the Type 1309-A with a two-wire power cord to eliminate the ground loop of Figure 3-2. (*No 60-Hz voltage since ground current does not flow through signal wire shield).

The "0V" position on the OUTPUT switch of the Type 1309 can be very useful in trying to reduce the effects of ground loops. Only the extraneous noise and hum appear at the device input when the oscillator is used in this position. The oscillator signal is removed, yet all of the wiring, shielding, and impedance levels connecting the two devices remain the same. The extraneous signals present are much easier to identify and measure in this case, since they are not masked by the oscillator output.

If the Type 1309 is rack mounted, the chassis will be connected to the rack frame ground and a ground loop can not be avoided by operating the instrument with a two-wire power connection. Again, this loop may cause an appreciable amount of hum at low levels if there are 60-Hz ground currents through the rack panels (Figure 3-4).

The effect of the ground currents may be reduced by isolation of the oscillator circuit ground from its chassis (Figure 3-5). As much as 10 ohms may be inserted to provide this isolation. A one-half watt resistor may be added by replacing the wire lead between AT101 and the front panel ground connection (see Figures 6-3 and 6-5) or by substituting the connecting wire link leading to AT101 on top of the printed circuit board. Paragraph 6.3 explains how to obtain access to the top of the board.

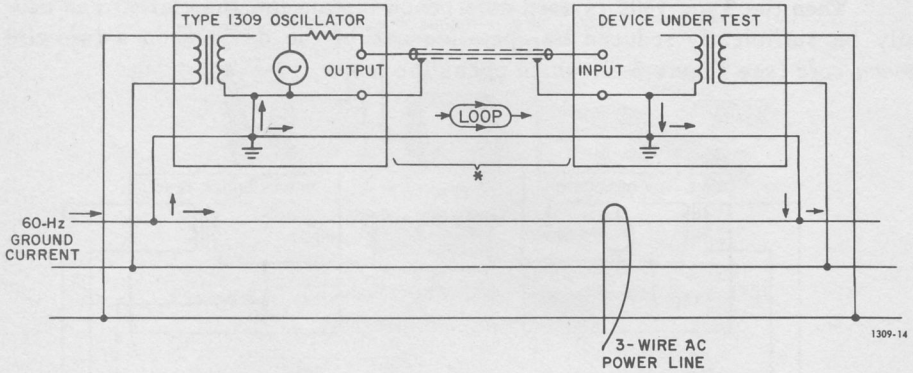

Figure 3-4. Ground loop formed when Type 1309 is rack mounted with another device, not necessarily ac-line operated (*60-Hz voltage due to panel ground currents and resistance).

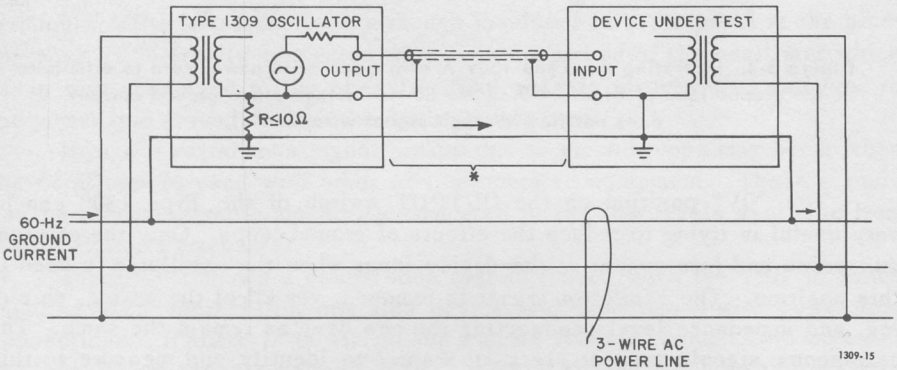

Figure 3-5. 60 Hz voltage due to panel ground current reduced because most of voltage appears across resistance R rather than resistance of signal wire shield.

3.4 CHARACTERISTICS.

3.4.1 FREQUENCY RESPONSE.

The output is 5 volts, open-circuit, behind 600 ohms and is adjustable over a 60-dB range by a step attenuator (20 dB per step) and a 20-dB bridged-T constant-impedance attenuator. The output is constant within $\pm 2\%$ from 10 Hz to 100 kHz for loads of 600 ohms or higher. Typically, within the audio range, changes are imperceptible on the usual analog type of voltmeter. The output voltage as a function of frequency of a typical oscillator is shown in Figure 3-6.

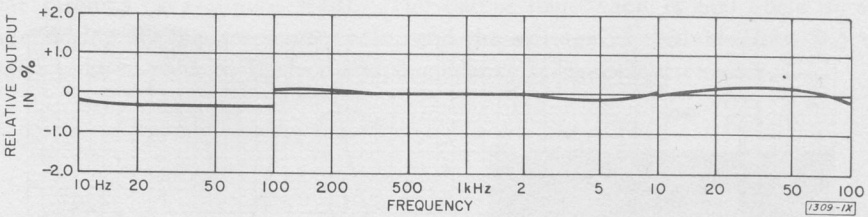

Figure 3-6. Typical oscillator output voltage versus frequency.

3.4.2 FREQUENCY STABILITY.

High-stability frequency-determining components in the oscillator and low internal power dissipation result in a stable output frequency. Drift during warm-up is typically below 0.1%.

Typical long-term stability after warmup at 1 kHz is shown in Figure 3-7. This graph was plotted under normal laboratory conditions during the winter months (heat on during the day and off at night).

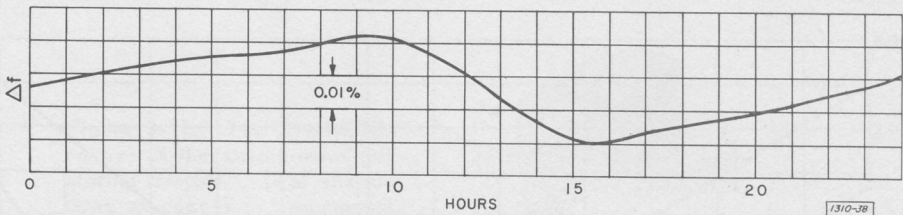

Figure 3-7. Typical long term drift.

3.4.3 NOISE.

Hum is less than $50\mu\text{V}$ (0.001% of full output), regardless of the attenuator setting. Noise at frequencies distant from a 1-kHz fundamental, measured in a bandwidth of 5 Hz to 500 kHz, is typically 0.005%. Noise close to the fundamental is also low, as the spectrum analysis of a 1-kHz output shows (Figure 3-8). Note the absence of components at the line frequency or its multiples. Refer to paragraph 3.3 for a discussion of how to minimize pickup of noise from external sources.

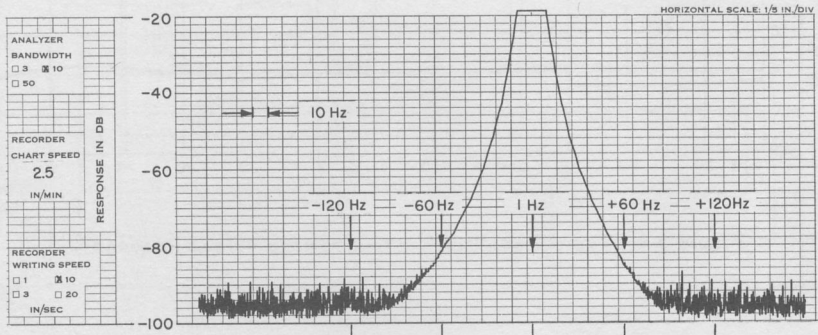

Figure 3-8. Spectrum analysis of the oscillator output at 1 kHz.

3.4.4 DISTORTION.

Total harmonic distortion (THD) is less than 0.05% from 200 Hz to 10 kHz, and less than 0.25% at 10 Hz and 100 kHz, with a 600 Ω load or open circuited (Figure 3-9). When the attenuator is set for open circuit voltages of one volt or less, the load seen by the oscillator is between 600 ohms and an open circuit regardless of the size of the external load.

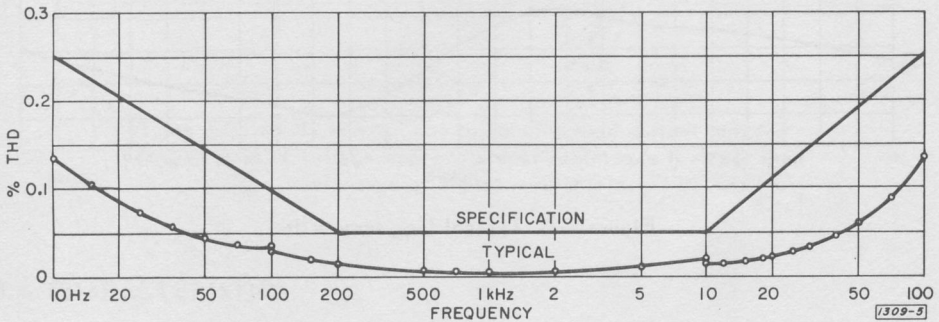

Figure 3-9. Typical harmonic distortion vs frequency of Type 1309 sine-wave output.

3.5 SQUARE-WAVE OUTPUT.

3.5.1 OUTPUT CHARACTERISTICS.

The square-wave output of the Type 1309 is positive-going from 0 volts to greater than +5 volts. It is dc coupled, so that there is no ramp-off. This makes the oscillator a convenient signal source for measuring the ramp-off of

other circuits (see Figure 3-10). The output impedance is 600 ohms at all times during the square-wave cycle, and the voltage is variable from 0.5 to 5 volts peak-to-peak by the constant-impedance bridged-T attenuator.

Figure 3-10. Direct-coupled 10-Hz square wave has flat top. Horizontal scale: 50 ms/div

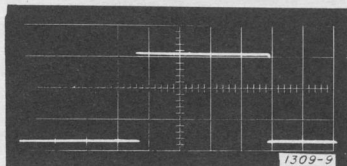

(d) 10 ms/cm

3.5.2 SYMMETRY.

The square-wave generator is triggered by the sine-waves produced by the oscillator. It has, therefore, the same frequency accuracy and stability. The waveform is symmetrical within $\pm 2\%$ over the whole frequency range. The transitions take place at the zero crossing of the sine wave. If, for a particular application, non-symmetrical pulses are required, the internal SYMMETRY control R303 (Figure 3-11) can be adjusted to trigger on a point on the sine-waveform other than the zero crossing. Duty ratios of down to about 20% are possible. For a more detailed explanation of the function of this control refer to paragraph 5.4.

Figure 3-11. The SYMMETRY control of the square-wave generating circuit. (For instructions on access to components, refer to paragraph 6-3.)

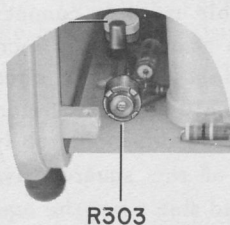

3.5.3 RISE TIME,

The transitions times of the square waves are very fast—less than 100 ns into 50Ω (Figure 3-12a). Still faster transitions are possible at full output and higher frequencies. The rise time is typically less than 40 ns into 50Ω at full output and 10 kHz. The compromise between minimum rise time and acceptable overshoot may be made for a particular load by the adjustment of C302 (Figure 3-13), the internal overshoot control.

The rise time of the square waves corresponds to the response time of an amplifier with a bandwidth greater than 10 MHz. This is well beyond the

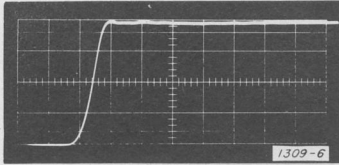

(a) 50 ns/cm

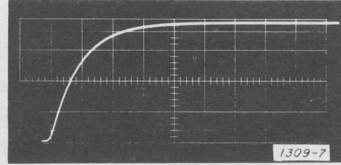
Figure 3-12a. Leading edge of 10 kHz square wave into 50- Ω load.

(b) 200 ns/cm

Figure 3-12b. Leading edge of same signal at open circuited end of cable.

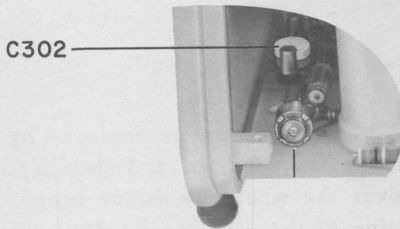

Figure 3-13. Overshoot control in the square-wave generating circuit. (For instructions on access to components, refer to paragraph 6-3.)

bandwidth normally encountered in audio equipment, but the fast internal transition can nevertheless be used to advantage for lower frequency testing. The rise time can be externally lengthened by using the time constant ($\sim 2.2 RC$) of the 600-ohm output impedance and the capacitance ($\sim 30\text{pF/foot}$) of the shielded cable used to connect the oscillator to the device under test. This produces a monotonically increasing leading edge with no overshoot or ripple and yet fast enough to check bandwidth up to 1 MHz. See Figure 3-12b for an example of this waveform.

A wide bandwidth indicator system must be used to reproduce faithfully the transitions of the square waves. For a system with n individual components of specified rise time, the equation for over-all rise time is

$$T_r = \sqrt{T_1^2 + T_2^2 + T_3^2 + \dots + T_n^2}$$

This means, for example, that a transition time of 50 ns would appear as a transition time of 70 ns if displayed on an oscilloscope with a 50 ns rise time.

3.6 SYNCHRONIZATION JACK.

3.6.1 GENERAL.

A telephone jack (EXT SYNC, J103) is located on the left-hand side of the oscillator. This is an input/output connector and is used to connect a signal *to* the oscillator or to take one *from* it.

There are three important characteristics associated with the use of the EXT SYNC feature:

1. Output characteristic.
2. Input synchronizing or phase-locking characteristic.
3. Input frequency-selectivity or filtering characteristic.

3.6.2 OUTPUT CHARACTERISTIC.

A nominal 1.5-volt, rms, output signal, behind 12 k Ω , is available from the EXT SYNC jack. The level of this sync output signal is independent of the LEVEL control or the front-panel OUTPUT load. One side of the sync output is grounded, as shown in Figure 3-14, and the signal is in phase with the front-panel OUTPUT.

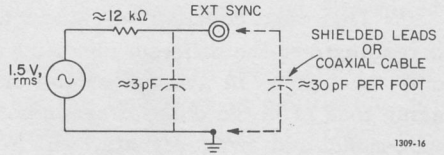

Figure 3-14. Diagram of the EXT SYNC output equivalent circuit.

The sync output will drive any size load without increasing oscillator distortion. However, only high-impedance loads are recommended where full frequency accuracy is required. The worst-case load, a short circuit, will decrease the frequency 1 or 2%.

Stray capacitance of most shielded leads or coaxial cables is about 30 pF per foot which, at 100 kHz, amounts to a shunt impedance of about 55 k Ω . For example, the open-circuited output voltage at the end of a five-foot shielded lead is less than one volt at 100 kHz. Therefore, cable length should be kept to a minimum when a high-impedance load is to be driven at high frequencies.

3.6.3 INPUT SYNCHRONIZING CHARACTERISTIC.

The oscillator frequency may be synchronized or locked with any input signal which is applied to the EXT SYNC jack, if the oscillator is tuned to the approximate frequency of the input. The range of frequencies over which this synchronization will take place is a function of the amplitude of the frequency component to which the oscillator locks. It increases approximately linearly, and produces a lock range of about $\pm 3\%$ for each volt input (see Figure 3-15).

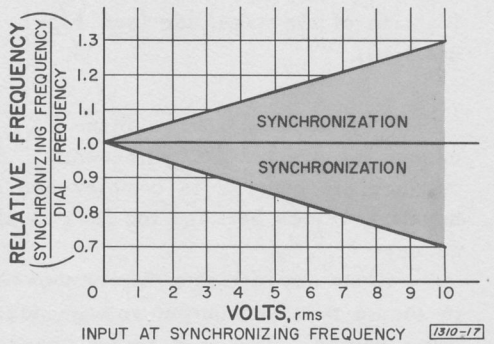

Figure 3-15. Locking range versus input voltage.



The oscillator maintains synchronization within the lock range if either the oscillator dial frequency or the synchronizing frequency is changed. However, there is a time constant of about one second associated with the synchronization mechanism. Thus if the amplitude or frequency of the sync signal or the dial setting of the oscillator is changed, there will be transient changes in amplitude and phase for a few seconds before the oscillator returns to steady-state synchronization.

This time constant is caused by the thermistor amplitude regulator as it readjusts to the different operating conditions. The thermistor is sensitive only to changes in average values of frequency or amplitude where the averaging time is in the order of seconds. Hence, frequency-modulated and amplitude-modulated sync signals, which have a constant average value of frequency and amplitude over a period of a second or less, are not affected by this time constant.

For slow changes in frequency or amplitude, the lock range and the capture range are the same; i.e., the frequency or amplitude at which the oscillator goes from the synchronized state to the unsynchronized state is the same as when it goes from the unsynchronized state to the synchronized state.

Synchronization is truly phase locking, that is, it maintains a constant phase difference between the sync input and the oscillator output. The phase difference is 0° when the dial frequency is identical to the sync frequency and approaches $\pm 90^\circ$ as the frequency approaches the limits of the locking range. Note that the phase difference is also a function of the amplitude of the sync signal because the lock range is a function of the amplitude (see Figure 3-16).

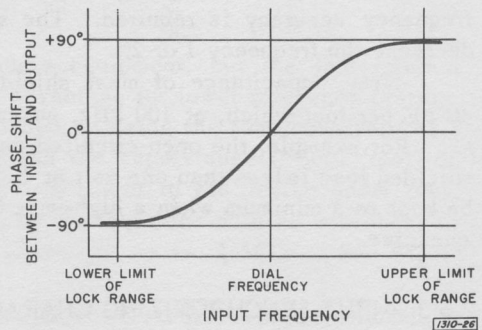

Figure 3-16. Phase shift relative to input frequency (and amplitude).

The *input impedance* of the EXT SYNC jack is $12\text{ k}\Omega$ at all frequencies except the synchronizing frequency. At the synchronizing frequency the impedance, in general, is complex and can vary over a wide range including negative values because the jack is also a source at the synchronizing frequency.

Since the jack is a simultaneous source and input, care should be taken to insure the sync output voltage does not interfere with the external sync drive source. The high output impedance of the EXT SYNC jack makes it easy to minimize the sync output signal. For example if the jack is fed from a 600-ohm source, less than 70 mV will appear across the source.

3.6.4 INPUT FREQUENCY SELECTIVITY.

The RC network in the oscillator used to determine the frequency of oscillation and to reduce hum, noise, and distortion can also be used to filter signals applied externally. Signals applied to the EXT SYNC jack, which are close to the frequency of synchronization, will be amplified in the output but those frequencies distant from the frequency of synchronization will be reduced. The intrinsic selectivity or Q of this filter is constant and determined only by the RC Wien network.

The voltage gain between the EXT SYNC jack and the OUTPUT terminals is constant at any frequency except the frequency of oscillation, regardless of the amplitude of the incoming signals. The curve of Figure 3-17 may be used directly to determine the amplitude of any frequency component in the oscillator output if the amplitude of the input is known.

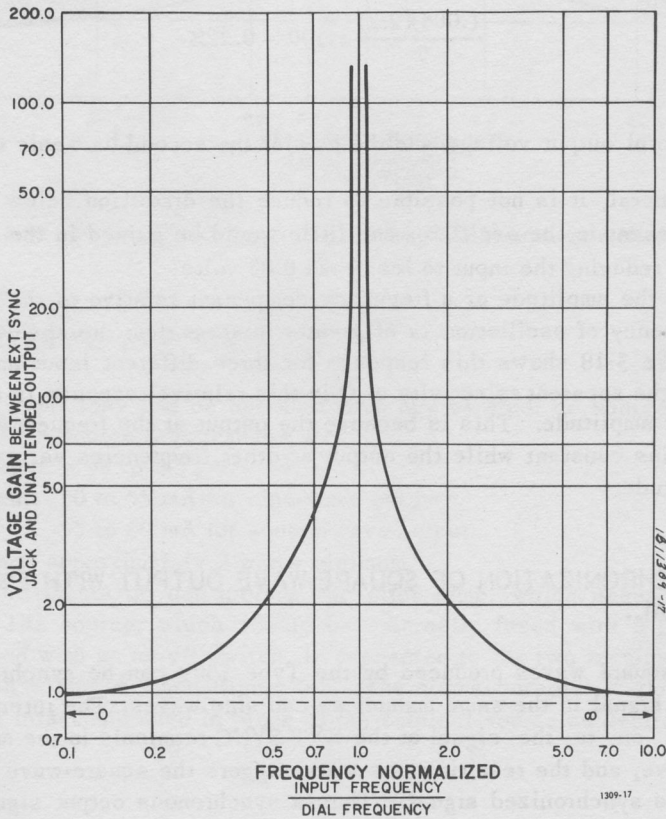

Figure 3-17. Voltage gain from EXT SYNC jack to OUTPUT as a function of distance from center frequency.



For example, we wish to determine the possible reduction in the harmonic content of a 1-volt, 1-kHz signal which has approximately 1.0% (0.01V) second-harmonic distortion by filtering with the Type 1309. The signal is applied to the EXT SYNC jack, and the OUTPUT control is set for a five-volt sine-wave output signal. From the graph, the gain at the second harmonic is approximately 2.2.

$$\text{distortion, in \%} = \frac{\text{amplitude of harmonics}}{\text{total amplitude}} \times 100 = \frac{2.2 \times 0.01}{5.0} \times 100 = 0.44\%$$

If the amplitude of the external signal is reduced to 0.5V (0.005-V harmonic content), the distortion at the output of the Type 1309 becomes

$$\frac{(.005)(2.2)}{5} \times 100 = 0.22\%$$

since the total output voltage and the gain at the second harmonic remain the same.

In general, it is not possible to reduce the distortion below the level normally present in the oscillator and little would be gained in the preceding example by reducing the input to less than 0.05 volts.

Often the amplitude of a frequency component relative to the amplitude of the frequency of oscillation is of greater interest than the absolute amplitude. Figure 3-18 shows this response for three different input amplitudes. Notice that the apparent selectivity or Q in this relative response is a function of the input amplitude. This is because the output at the frequency of oscillation remains constant while the output at other frequencies varies with the input amplitude.

3.6.5 SYNCHRONIZATION OF SQUARE-WAVE OUTPUT WITH EXTERNAL SIGNAL.

The square waves produced by the Type 1309 can be synchronized to an external signal in the same manner as can sine waves. The internal oscillator locks on to the signal at the EXT SYNC terminals in the manner described above, and the resulting sine wave triggers the square-wave generator to produce a synchronized signal. Thus a synchronous output signal whose shape and amplitude is independent of the shape of the input signal is generated. This characteristic will prove useful in, for instance, the generation of harmonics of the original signal.

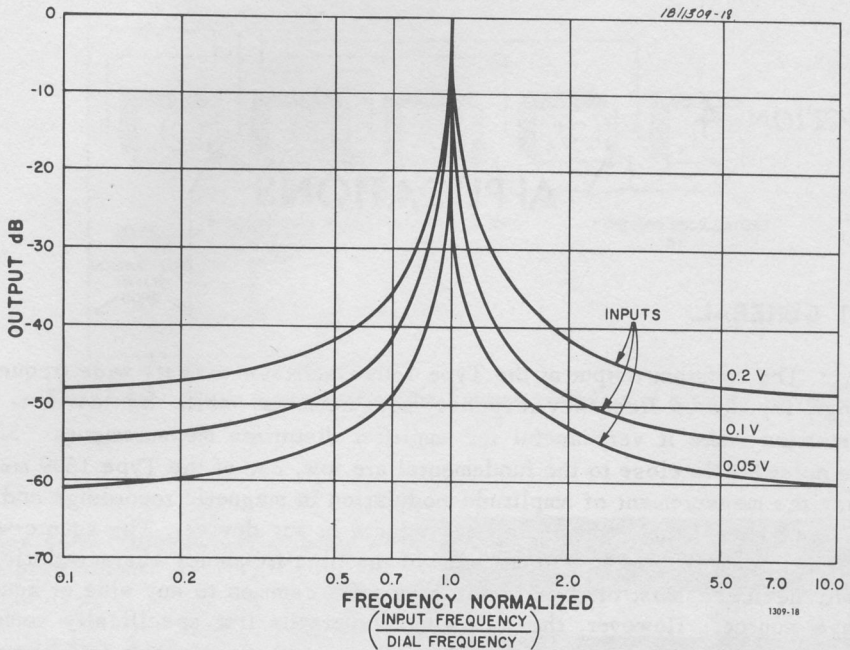

Figure 3-18. Frequency response of the Type 1309-A for three different inputs.

3.6.6 BATTERY OPERATION.

The Type 1309 can be operated from any external dc source, including batteries. The source requirements are:

Voltage: + 38 to + 52 V

Current: 50 to 55 mA for sine-wave output

55 to 60 mA for square-wave output

Power: approximately 2 watts minimum

These requirements do not include the pilot lamp, which needs 6 volts at 200 mA. The source, which should be externally fused with a 1/16-A fuse and equipped with an on-off switch, is connected to the two terminals of C501 as shown in Figure 6-3 and Figure 6-5. The normal internal ac power supply may be left intact and used in place of the external source as desired.



SECTION 4

APPLICATIONS

4.1 GENERAL.

The constant output of the Type 1309 Oscillator over its wide frequency range facilitates frequency-response measurements, while its low hum and distortion make it very useful for amplifier distortion measurements. Since the noise levels close to the fundamental are low, use of the Type 1309 makes easy the measurement of amplitude modulation in magnetic recordings and the measurement of the intermodulation products in any device. The square-wave output allows the direct measurement of the high-frequency characteristics of many devices. Most of these applications are common to any sine or square-wave source. However, the following paragraphs list specifically some of the more interesting applications of the Type 1309 which result from the synchronization feature.

4.2 SLAVED OSCILLATORS.

Because the EXT SYNC jack is simultaneously an input and an output connector, two or more oscillators can be synchronized if their EXT SYNC jacks are connected together. Oscillators connected in this manner will operate at the same frequency or multiples of the same frequency and can be made to differ in phase ($\pm 75^\circ$) by adjustment of the FREQUENCY dials within the lock range.

4.3 WAVEFORM SYNTHESIZER.

The ability to lock onto harmonics lends the oscillator to interesting applications such as the Fourier synthesis of waveforms.

In the following example, a square wave is synthesized by locking the oscillators on the successive odd harmonics present in the original square wave. Any waveform can be synthesized in this manner, provided a source of the necessary harmonics is available and the Fourier coefficients are known.

All sync inputs are paralleled and connected to the oscilloscope's square-wave calibrator output, as shown in Figure 4-1. The resulting waveform is shown in Figure 4-2.

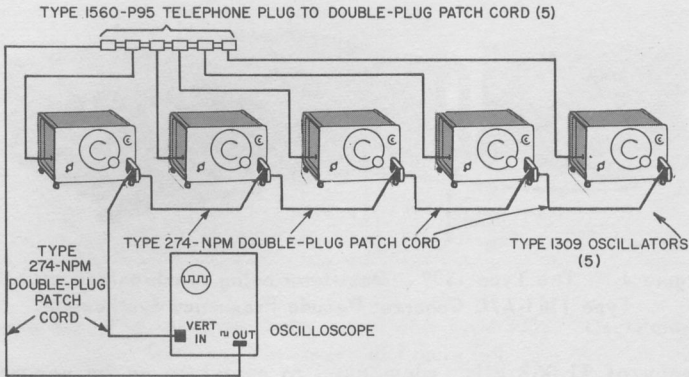

Figure 4-1. Set-up for generating the Fourier synthesis of a square wave.

Figure 4-2a. Original 1-kHz square wave from oscilloscope.



Figure 4-2b. Fifth harmonic which, like the output of all the oscillators, is sinusoidal.

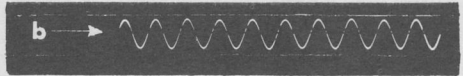
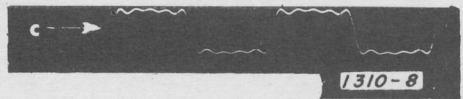

Figure 4-2c. Synthesized square wave. The five outputs are adjusted for phase coherence and are summed in the ratio of their respective Fourier coefficients.



4.4 ACCURATE FREQUENCY SOURCE WITH CLEAN, HIGH, SHORTABLE OUTPUT.

One obvious application for the sync capability is to lock one or more oscillators to a reference frequency for higher accuracy and greater long-term stability. With the oscillator synchronized, its accuracy and long-term stability will be identical with the reference; short-term stability or jitter will be the same as if the oscillator were free-running. (See Figure 4-3.)

A Type 1309 is locked to the output of a Type 1161-A7C Coherent Decade Frequency Synthesizer, used here as the reference-frequency source. The oscillator increases the 2-volt output of the synthesizer and reduces the already low harmonic content for a precision frequency-modulation experiment.



Figure 4-3. The Type 1309 Oscillator being synchronized with the Type 1161-A7C Coherent Decade Frequency Synthesizer.

The frequency of 31.063 kHz, when used to modulate an fm generator, produces a null in the carrier for a ± 75.000 -kHz frequency deviation.

The advantages of this arrangement accrue from the output characteristics of the oscillator listed in the following paragraphs.

4.4.1 DISTORTION AND HUM REDUCTION.

The frequency selectivity of the synchronized oscillator reduces distortion and hum in the reference source.

For example, Figure 4-4 below is the spectrum of a typical 1-kHz, sinusoidal, frequency reference signal, derived by division from a crystal oscillator.

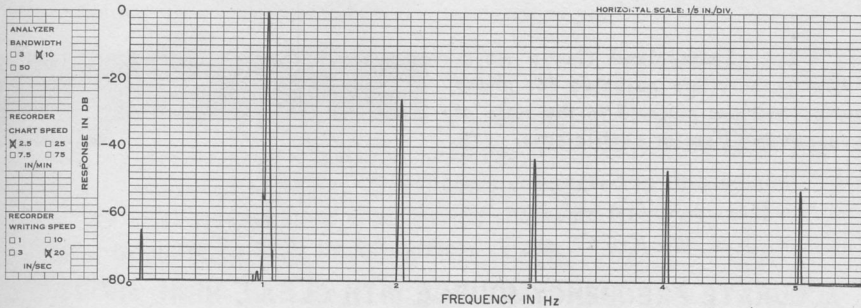

Figure 4-4. The spectrum of a typical 1 kHz reference frequency signal.

Figure 4-5 is the spectrum of the output of a Type 1309 Oscillator synchronized to the 1-kHz frequency of Figure 4-4. Note the significant reduction in distortion, noise, and hum.

4.4.2 FREQUENCY MULTIPLICATION.

The harmonic content of the reference can be used for precise frequency multiplication since the oscillator can be synchronized to the harmonics. The

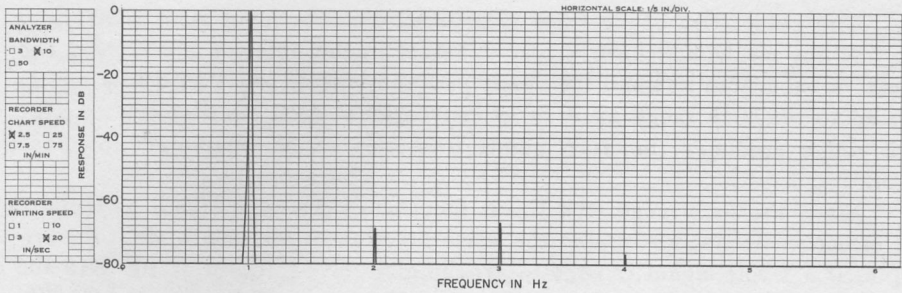

Figure 4-5. The spectrum of the output of a Type 1309 Oscillator locked to the source of Figure 3-4.

accuracy and long-term stability of the submultiple reference are maintained and the oscillator output is, of course, sinusoidal. This technique can be used with most signals because harmonics are usually present or can be easily generated.

4.4.3 OTHER CONTRIBUTIONS.

In addition to the above capabilities, the Type 1309 Oscillator also provides amplification, isolation, amplitude stabilization, and level control. Less than a volt into the high-impedance EXT SYNC jack produces a full 5-volt open-circuit, or 10-mW into 600 ohms, output. The oscillator protects the reference source from short circuits and nonlinear loads. The output has the same long-term amplitude stability as the normal unsynchronized output and is thus free from changes in the output level of the reference source. The oscillator provides adjustable output levels which are kept constant automatically with changes in frequency.

4.5 TRACKING, NARROW-BAND FILTER.

4.5.1 JITTER OR INCIDENTAL FM REDUCTION.

Although the short-term stability or jitter* of the synchronized oscillator can not be better than when it is free-running, it can be better than the source to which it is synchronized. In this respect it behaves as a phase-locked oscillator or automatic-phase-control (APC) oscillator.** Or, to express it differently, it behaves as a tracking, narrow-band filter to reduce short-term instability.

* See D.D.Weiner and B.J.Leon, "The Quasi-Stationary Response of Linear Systems to Modulated Waveforms," *Proceedings of the IEEE*, Vol 53, June 1965, pp 564 to 575 and references.

** Harold T. McAleer, "A New Look at the Phase Locked Oscillator," *Proceedings of the IRE*, Vol 47, pp 1137 to 1143, June 1959 (GR Reprint No. A-79).



The selectivity of the filter is a function of the input sync signal, and the tracking mechanics have a time constant in the order of a second. The effective bandwidth to small frequency perturbations or small fm deviations is related to the lock range as it is in conventional APC oscillators; i.e., the lock range produces the 3-dB cutoff frequency of an equivalent low-pass filter.

Since the lock range is a linear function of the sync-signal amplitude, the effective bandwidth is also the same function of the amplitude. For example, if a 1-volt signal is used to synchronize the oscillator at 100 kHz and provides a $\pm 3\%$ lock range, the oscillator will have a 3-dB bandwidth of 3 kHz (3% of 100 kHz) to perturbations in frequency. Thus frequency deviations in the 100-kHz source at a 3-kHz rate will be reduced 3 dB in the oscillator output.

Figure 4-6 shows one example of jitter reduction. Note the cycle-to-cycle change in frequency has been greatly reduced, yet the relatively long-term change of about 1% has been faithfully tracked.

The low frequency used in this example was chosen for convenience in making the graphic recordings. A reduction in jitter or fm can be made at any frequency within the range of the oscillator (10 Hz to 100 kHz). The ability to track drift, however, is still limited by the one-second time constant of the thermistor.

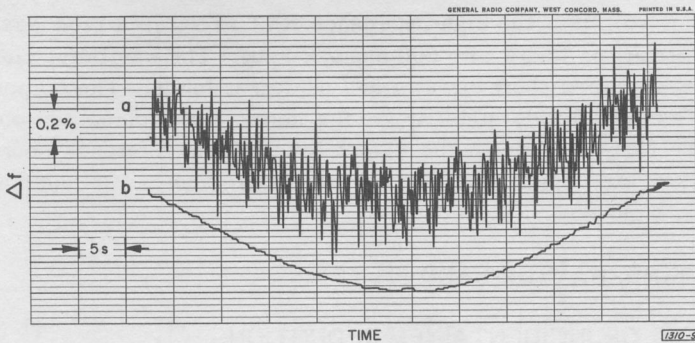

Figure 4-6. One example of jitter reduction.

- a. Output frequency of a drifting, jittery 10-Hz source.
- b. Output of the Type 1309 synchronized to the 10-Hz source.

4.5.2 INCIDENTAL A-M REDUCTION.

Just as the oscillator can be used to reduce jitter or fm in a signal, it can also be used to reduce a-m. This is a natural consequence of the oscillator's similarity to a high-Q filter. The amplitude modulation on any signal to which a Type 1309 is synchronized is reduced to the extent that the modulation sidebands fall outside the passband of the oscillator.

The reduction can be calculated from Figure 3-18. For example, we wish to determine the reduction in amplitude modulation of a 0.1-volt, 10-kHz

signal which has 10% amplitude modulation at 1 kHz (5% or 0.005 V in each sideband). The signal is applied to the EXT SYNC jack of the Type 1309, the output of the Type 1309 is 5 volts and, from the graph, the gain at 9 kHz and at 11 kHz is 15.7.

$$\text{a-m, in \%} = \frac{\text{amplitude of sidebands}}{\text{total amplitude}} \times 100 = \frac{(15.7 \times .005) + (15.7 \times .005)}{5} \times 100 = 3.14\%$$

Figures 4-7a and 4-7b show examples of am reduction.

Figure 4-7. One example of a-m reduction.

a. 10-kHz signal modulated at 500 Hz and applied to EXT SYNC jack.

b. Reduction in a-m in the output of the oscillator locked to the signal above.

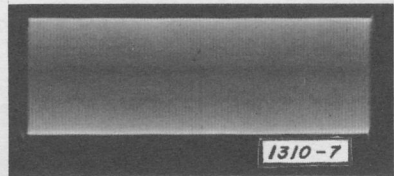
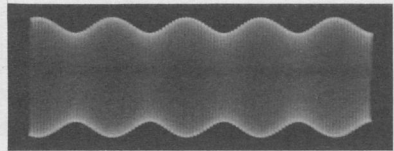

4.6 AMPLITUDE-MODULATED OSCILLATOR.

If the oscillator is operated outside of the lock range, the sync signal will beat with the oscillator frequency and produce an audio-frequency, amplitude-modulated output. The modulation will be approximately sinusoidal for modulation levels up to about 10%.

This arrangement is not ideal, but it does provide amplitude-modulated signals in the audio range where normally they are not conveniently obtainable. Modulated outputs of this type can be used to measure the effects of incidental a-m on other measurements and to provide a modulated source to reduce meter-friction errors in ac measurements.

Figure 4-8 shows one example of amplitude modulation.

Figure 4-8. 10-kHz output of an oscillator modulated at 500 Hz by a 9.5-kHz signal applied to the EXT SYNC jack.

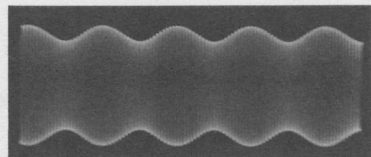



4.7 OUTPUT SYNC.

4.7.1 OSCILLOSCOPE TRIGGER (Figure 4-9).

Since the sync output is independent of the output level, it can be used to trigger an oscilloscope in applications where the oscillator output is often varied, thereby eliminating frequent readjustment of the oscilloscope trigger circuits.

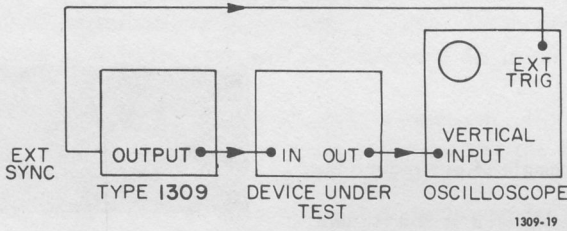

Figure 4-9. EXT SYNC signal used to trigger an oscilloscope.

4.7.2 COUNTER TRIGGER (Figure 4-10).

A counter can be driven from the EXT SYNC jack when more precise adjustment of frequency is desired or when the front-panel output is not sufficient to trigger the counter.

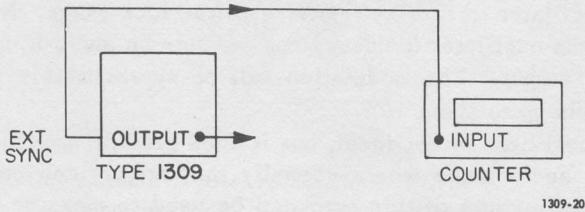

Figure 4-10. EXT SYNC signal triggers frequency counter.

SECTION 5

PRINCIPLES OF OPERATION

5.1 GENERAL.

As shown in Figure 5-1, the Type 1309 Oscillator is a capacitively tuned Wien bridge oscillator with range changing accomplished in four decade steps by the changing of R_A and R_B . A large amount of negative feedback is used and is responsible for the very low distortion of the sine-wave output.

The 5-volt output of the Wien bridge oscillator is switched either to be attenuated by a 60-dB step attenuator or (in the 5 V p-p square wave position) to drive a modified high-speed Schmitt circuit, which generates a very fast (less than 100-ns rise time) square wave. The square wave is dc coupled to the output through the 0-20-dB adjustable attenuator.

The EXT SYNC jack connects to the negative feedback loop of the Wien bridge oscillator.

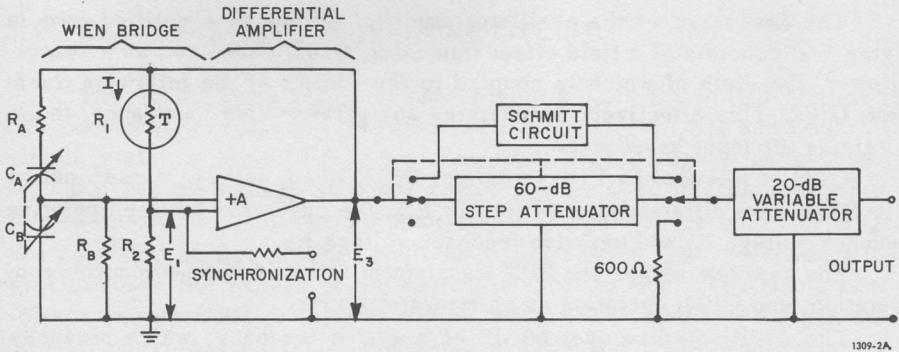

Figure 5-1. Block diagram of the Type 1309-A low distortion oscillator.

5.2 THE WIEN BRIDGE OSCILLATOR.

The oscillator circuit is shown in simplified form in Figure 5-2. The Wien bridge can be thought of as consisting of two parts: a frequency determining network (C_A , C_B , R_A , and R_B), which supplies positive feedback to sustain oscillation; and a voltage divider (R_1 and R_2), from which is taken



negative feedback to stabilize the amplitude. The frequency determining network has the following transfer function.

$$\frac{E_{OUT}}{E_{IN}} = \frac{1}{3 + j \left(\frac{f}{f_o} - \frac{f_o}{f} \right)} \quad \text{where,}$$

$$f_o = \frac{1}{2\pi RC}, \quad R = R_A = R_B, \quad C = C_A = C_B.$$

At the frequency, f_o , this function equals $+1/3$. This frequency is determined by the ganged variable capacitors C_A and C_B , and one of four pairs of precision metal-film resistors, R_A and R_B , selected by the FREQUENCY RANGE switch.

The resistive divider, $R1$ and $R2$, is used to set the gain of the associated amplifier chain that is, the ratio E_1/E_3 , to $+3$. The net gain of the bridge-amplifier loop is then $+1$, and the circuit oscillates at the frequency f_o . The resistance of thermistor $R1$ adjusts to the value needed to maintain constant amplitude oscillation. The time constant of the thermistor is short enough to provide a rapid correction for amplitude variations, but long enough to cause little distortion at the lower frequencies. (The thermistor operates at a high temperature in an evacuated bulb, to minimize the effects of ambient temperature.)

5.3 THE OSCILLATOR AMPLIFIER.

The first stage of the oscillator amplifier (shown in simplified form in Figure 5-2) consists of a field effect transistor, $Q101$, connected as a source-follower, the drain of which is coupled to the emitter of the following transistor, $Q102$. This effectively degenerates any gate-to-drain impedance, thereby raising the input impedance.

$Q101$ is followed by PNP transistor $Q102$, which serves, in combination with $Q101$, as a differential amplifier for E_{in} , the difference between positive feedback voltage E_1 and negative feedback voltage E_2 .

The next two stages are NPN transistors: $Q103$, in common-emitter configuration, and $Q104$, operating as an emitter-follower.

The oscillator has over 60 dB of negative feedback, which produces three results: low distortion, very high input impedance and very low output impedance.

Both the signal output and the positive feedback for the Wien bridge are taken from the emitter of $Q104$. The sine-wave output signal is transmitted through a 600- μ F coupling capacitor to switch $S201$, which forms a 60-dB step attenuator in the first four positions and connects, in the fully clockwise position, the square-wave generating circuit to the oscillator output. The output from the step attenuator is applied to the output jack via a 20-dB, constant-impedance bridged-T attenuator, $R205$ through $R208$.

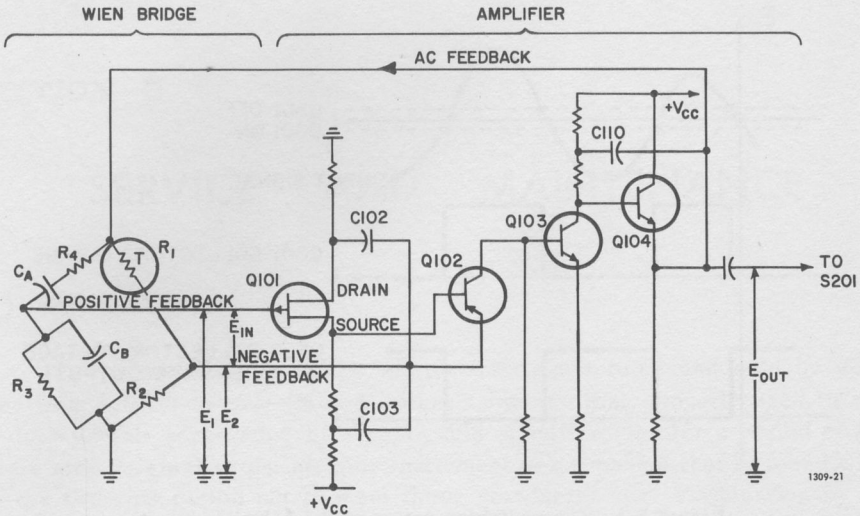

Figure 5-2. Simplified schematic diagram of the Wien bridge oscillator circuit used in the Type 1309-A.

The dc operating conditions are maintained by the negative dc feedback divider R108 and R109. The proper bias level is set with R102. The complete circuit of the oscillator appears in Figure 6-5.

5.4 THE SQUARE-WAVE GENERATING CIRCUIT.

The square-wave generator (see Figure 6-5) is a modified Schmitt circuit consisting of two emitter-coupled PNP transistors, Q301 and Q302. The circuit works in the following way. An input signal slightly more negative than the emitter voltage of Q301, applied to the base of Q301, causes it to turn on (conduct). This forms a positive-going signal at the collector of Q301 and the base of Q302. This positive signal causes Q302 to conduct less, which causes the voltage at the emitter of Q301 to rise. The rising emitter voltage causes Q301 to conduct all the harder. The result is a regenerative process which leaves Q301 conducting heavily and Q302 conducting not at all. When the input signal goes a bit more positive than the voltage on Q301's emitter, a similar regenerative process occurs which leaves Q301 off and Q302 on. The action of the Schmitt circuit is illustrated in Figure 5-3.

Trimmer C302 is a speed-up capacitor which determines how rapidly Q302 switches on and off, and thereby, the shape of the output waveform, which appears at the collector of Q302.

For maximum switching speed, Q301 is prevented from saturating by the network including CR301 and CR302. Diode CR303 prevents the base-emitter voltage of Q301 from becoming excessive during the positive swing of

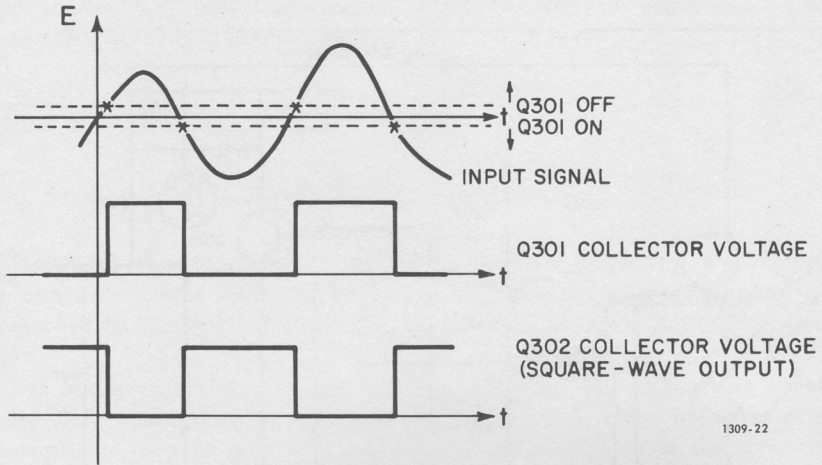

Figure 5-3. The switching action of the Schmitt circuit.

the input signal. The exact point on the input waveform at which the switching of Q301 takes place is set by R303, the SYMMETRY control, which adjusts the bias at the base of Q301.

5.5 THE POWER SUPPLY.

The power supply, (see Figure 6-5) consists of a full-wave rectifier (CR501 and CR502) followed by a pi-section filter (R501 and C501, A and B) and a constant-voltage regulator (Q501). The base voltage of Q501 is held fixed at +33 volts by Zener diode CR503; the emitter, therefore, is held at a fixed voltage. The power transformer T501 is wired so that either a 115-volt or a 225-volt ac power source can be used, depending on the setting of S502, the LINE switch.

SECTION 6**SERVICE AND MAINTENANCE****6.1 WARRANTY.**

We warrant that each new instrument manufactured and sold by us is free from defects in material and workmanship and that, properly used, it will perform in full accordance with applicable specifications for a period of two years after original shipment. Any instrument or component that is found within the two-year period not to meet these standards, after examination by our factory, Sales Engineering Office, or authorized repair agency personnel, will be repaired or, at our option, replaced without charge, except for tubes or batteries that have given normal service.

6.2 SERVICE.

The two-year warranty stated above attests the quality of materials and workmanship in our products. When difficulties do occur, our service engineers will assist in any way possible. If the difficulty cannot be eliminated by use of the following service instructions, please write or phone our Service Department (see rear cover), giving full information of the trouble and of steps taken to remedy it. Be sure to mention the serial and type numbers of the instrument.

Before returning an instrument to General Radio for service, please write to our Service Department or nearest Sales Engineering Office, requesting a Returned Material Tag. Use of this tag will ensure proper handling and identification. For instruments not covered by the warranty, a purchase order should be forwarded to avoid unnecessary delay.

6.3 ACCESS TO COMPONENTS.

To remove the cover of the Type 1309-A, turn the two knurled nuts on the rear of the cover counterclockwise and pull the cover straight back and off.

To obtain access to the components on the etched board, disconnect from the etched board the six wires that are connected to the FREQUENCY range switch, remove the two securing screws, and swing the board up. (See Figure 6-1.)

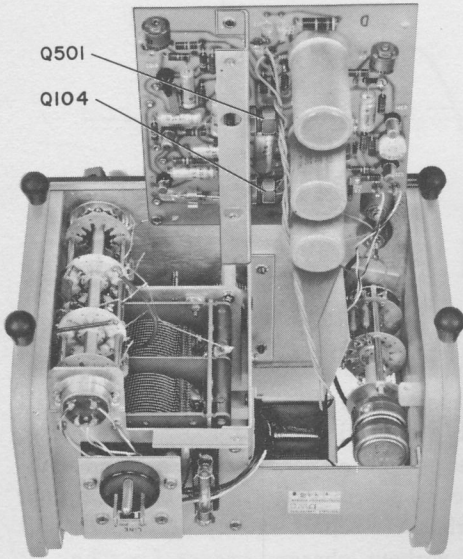



Figure 6-1.
Access to the etched-board components.

6.4 MINIMUM PERFORMANCE SPECIFICATIONS.

The check of specifications outlined in Table 6-1 is recommended for incoming inspection or periodic operational testing. Detailed procedures are given in the Calibration Procedure, paragraph 6.7.

Conditions: 115-V line, 30-minute warmup.

TABLE 6-1 MINIMUM PERFORMANCE SPECIFICATIONS					
OUTPUT LEVEL			FREQUENCY		Specifications
Check	Switch	Control	Range Setting	Dial Setting	
Output level	5V	fully cw	100Hz-1kHz	10	5 ± 0.25 V rms (open circuit)
Frequency	5V	fully cw	each	5	±2% of indicated value
Distortion	5V	fully cw	100Hz-1kHz	2	< 0.05%
			1kHz-10kHz	10	< 0.05%
Hum	50mV	fully cw	100Hz-1kHz	10	< 50 μV
Sync output	—	—	100Hz-1kHz	10	≈ 1.5 V
Output power	5V	fully cw	100Hz-1kHz	10	≥ 2.45 V into 600Ω (10 mW)
Output response	5V	set for 1V, rms	100Hz-1kHz	10	—
			10Hz-100Hz	1	0.98-1.02 V
			10kHz-100kHz	10	0.98-1.02 V
Square wave					
Rise time	5V	fully cw	1kHz-10kHz	10	< 100 ns into 50Ω
Symmetry	P-P	fully cw	100Hz-1kHz	10	±2% (48-52% duty ratio) on scope trace, or less than 6% 2nd harmonic component to funda- mental
OUTPUT		fully cw	100Hz-1kHz	10	≥ 5 V p-p

6.5 TROUBLE-SHOOTING NOTES.

Tables 6-2 and 6-3 offer means of isolating the more straight-forward difficulties that might occur in the Type 1309-A. Additional troubleshooting information is contained in the Calibration Procedure, paragraph 6.7, and on the schematic diagram, Figure 6-5.

In all cases, except total failures such as a blown fuse, first check the power supply voltages and dc operating level. These must be correct for proper operation.

NOTE: Always allow a 30-minute warmup before making any final adjustments.

TABLE 6-2
SPOT CHECK OF
IMPORTANT VOLTAGE LEVELS

SUPPLY	VOLTAGE	TEST POINT
Power	+ 32 V DC	Emitter Q501
DC bias	+ 18.0 V DC	TP A

TABLE 6-3
TROUBLE SYMPTOMS AND THEIR CAUSES
(See Figures 6-2 through 6-5 for component locations.)

Inaccurate frequency	<i>10kHz-100kHz range.</i> C105 misadjusted, refer to paragraph 6.7.5 for adjustment procedure. <i>One range only:</i> R _a or R _b for that range. <i>Lower ranges:</i> Dirt, grease, or high humidity may have affected R _a or R _b , frequency will be too high. <i>All ranges:</i> C _a or C _b or improper frequency adjustments, refer to paragraph 6.7.5 for adjustment procedure.
Excessive distortion	DC bias improper, adjust R102 for +18V at TP A.
Excessive hum	Power supply not regulating properly.
Poor response	(Output varies with frequency) R111 (thermistor) or grossly improper frequency adjustments, refer to paragraph 6.7.5 for adjustment procedure.
Instability or excessive noise	Dust between plates of C401 or wiper dirty or otherwise making poor contact.



6.6 AMPLIFIER OPEN-LOOP TESTING.

The amplifier uses a large amount of ac feedback, so that trouble at any one point in the circuit will manifest itself at most other points. For this reason it may be difficult to isolate a failure under closed-loop conditions; therefore the following open-loop test is recommended:

- a. Unsolder the lead to AT111 on the etched board and unsolder one end of the thermistor, R111 to open the ac feedback path (see Figure 6-4).
- b. Set the controls as follows:
 FREQUENCY range 10 kHz - 100 kHz
 FREQUENCY dial 1 (10 kHz)
 OUTPUT switch 5V
 OUTPUT control fully cw
- c. Apply a 60-mV, p-to-p, 1-kHz signal to the EXT SYNC jack, J401.
- d. Trace the signal through the amplifier with an oscilloscope, using a short, low-capacitance, high-impedance probe to prevent spurious oscillation.

The voltages observed should agree with those of Table 6-4, and the waveforms should all be sine waves.

**TABLE 6-4
 OPEN-LOOP VOLTAGES AND WAVEFORMS
 IN THE OSCILLATOR AMPLIFIER**

Test Point	Voltage (peak-to-peak)
AT109	60mV
AT110	30mV
Q101, drain and source	30mV
Junction of R105, C103	30mV
AT108	30mV
Q102, collector	40mV
Q103, emitter	30mV
Q103, collector	14V
Q104, emitter	14V
Junction of R115, C110	14V
AT111	14V

Voltages are approximate. Actual voltages may vary 2 to 1 in individual instruments.

6.7 CALIBRATION PROCEDURE.

6.7.1 INTRODUCTION.

This procedure can be used for troubleshooting or calibration.

If used for trouble shooting, the steps can be performed in any order. The usual practice would be to perform only the step that pertains to the suspected circuit.

If used for calibration, the steps should be performed in sequence since one step serves as a foundation for the next. A complete calibration insures that all circuits are operating properly and within specifications. The Type 1309 Oscillator incorporates the high reliability one would expect of conservatively designed, semiconductor circuits and routine calibrations are unnecessary.

6.7.2 EQUIPMENT.

The following equipment is required for a complete calibration of the Type 1309 Oscillator. The specifications given for the equipment are those necessary for the calibration of the Type 1309 and are not necessarily those of the recommended equipment.

Metered, adjustable autotransformer

Output: 105 to 125 V (or 195 to 235 or 210 to 250 V), 12 W.

Meter: Ac, $\pm 3\%$ accuracy.

The Type W5MT3W Metered Variac[®] Autotransformer is recommended.

Electronic voltmeter

Voltage: 0 - 50 V, dc; 5mV - 5 V ac, rms, 10 Hz 100 kHz, $\pm 2\%$ accuracy.

Impedance: 100 k Ω or greater.

Digital frequency meter (counter)

Frequency: 10 Hz to 100 kHz, $\pm 0.1\%$ accuracy

Sensitivity: 1 V, rms.

Impedance: 100 k Ω or greater.

The Type 1151 Digital Time and Frequency Meter is recommended.

The frequency accuracy of the Type 1309 is $\pm 2\%$. The counter accuracy should be at least 20 times this, or 0.1%, to prevent counter errors from entering into the measurements. The \pm one-count uncertainty in a counter with a 100-kHz time base represents an error of greater than 0.1% unless the



measurement conditions are as follows:

above 1000 Hz; direct frequency measurement, 1-second counting interval.

below 1000Hz; period measurement, 10-period count.

Oscilloscope

Bandwidth: dc to 30 MHz (-3 dB points)

Sensitivity: 50 mV

Impedance: 100 k Ω or greater.

The Tektronix Type 543/543A Oscilloscope with a Type CA Plug-in and Type P6000 Probe is recommended.

Wave Analyzer and/or Distortion Meter

Frequency: 10 Hz to 100 kHz.

Sensitivity: 50 μ V to 5 V

Impedance: 100 k Ω or greater.

The Type 1900-A Wave Analyzer and the Hewlett Packard Type 334-A Distortion Meter are recommended.

Test Oscillator

Frequency: 1 kHz.

Amplitude: 1 V into 25 k Ω .

The Types 1309, 1310 and 1311 Oscillators are recommended.

Load resistors

50 Ω \pm 1%, 1W. The Type 500-C Resistor is recommended.

600 Ω \pm 1%, 1W. The Type 500-G Resistor is recommended.

Cables

Telephone-plug to double plug. The Type 1560-P95 Cable is recommended.

6.7.3 POWER SUPPLY and BIAS VOLTAGES.

Connect the Type 1309 to an ac line via a metered adjustable auto-transformer and set the transformer for 115-V output. Set the Type 1309 controls as follows:

FREQUENCY range 100 Hz - 1 kHz

FREQUENCY dial 10 (1 kHz)

OUTPUT switch 5 V

OUTPUT control. fully cw

Power Supply. Connect a voltmeter to the emitter of Q501. Voltage should be 32 ± 2 volts dc. If not, check CR503 and replace if necessary.

Bias. Connect a voltmeter to TPA and adjust R111 for +18 V, dc.

Ripple. Connect the oscilloscope to the emitter of Q501 and check ripple at 100, 115, and 125-V line; must be less than 10 mV, p-to-p.

Allow a 30-minute warmup then recheck the adjustment of R111.

6.7.4 OUTPUT LEVEL.

FREQUENCY range 100 Hz - 1 kHz
 FREQUENCY dial 10 (1 kHz)
 OUTPUT 5 V
 OUTPUT control fully cw

Maximum output. Connect a voltmeter to the OUTPUT terminal and adjust R112 for 5 V, rms. The instrument should be on for at least 30 minutes before this adjustment is made.

OUTPUT control operation. Vary the OUTPUT-control over its full range the output level must change smoothly. If it does not, the OUTPUT potentiometer, R205, is noisy and should be replaced.

6.7.5 FREQUENCY

FREQUENCY range 1 kHz - 10 kHz
 FREQUENCY dial 1 (1 kHz)
 OUTPUT switch 5 V
 OUTPUT control. fully cw

1 kHz mechanical adjustment. Connect the counter and voltmeter to the EXT SYNC jack and set the FREQUENCY dial for a frequency count of exactly 1.000 kHz. Loosen the set screws on the FREQUENCY dial and position the dial on the shaft to read exactly 1 with a reading of 1.000 kHz on the counter. Snug-up the set screws but don't tighten. Note the voltmeter reading.

10 kHz, capacitor adjustments. Set the FREQUENCY dial to exactly 10. Simultaneously adjust C402 and C403 for a counter frequency reading of exactly 10 kHz and the same voltmeter reading noted above.

The mechanical adjustment and capacitor adjustments interact: repeat until the measurements are correct and the voltmeter readings are equal at both ends of the dial.



Stability. Disconnect the voltmeter and connect an oscilloscope in its place. Rotate the FREQUENCY dial over the entire 1 kHz - 10 kHz range; there must be no instability or other erratic operation. If there is, it is usually caused by the rotor wiper arm of the tuning capacitor, C401, or dust in C401. Disconnect the oscilloscope. Remove all connections to the EXT SYNC jack.

100 kHz adjustment. Set the FREQUENCY range to 10 kHz - 100 kHz and set the FREQUENCY dial to 10. Adjust C105 for a counter frequency reading of exactly 100 kHz.

Frequency checks. Perform the following frequency checks:

TABLE 6-5 FREQUENCY CHECK			
Range Setting	Dial Setting	Counter Reading	Remarks
*1kHz-10kHz	1(1kHz)	Frequency: 980 to 1020Hz	*Mechanically position FREQUENCY dial
1kHz-10kHz	1.5(1.5kHz)	Frequency: 1470 to 1530Hz	
1kHz-10kHz	2.5(2.5kHz)	Frequency: 2450 to 2550Hz	
1kHz-10kHz	5(5kHz)	Frequency: 4900-5100Hz	*Adjust C402 and C403
*1kHz-10kHz	10(10kHz)	Frequency: 9800-10,200Hz	
100Hz-1kHz	5(500Hz)	Ten period 19.6 to 20.4 ms	
10kHz-100kHz	5(50kHz)	Frequency: 49 to 51kHz	*Adjust C105
*10kHz-100kHz	10(100kHz)	Frequency: 98.0 to 102kHz	
10Hz-100Hz	10(100Hz)	Ten period 98 to 102 ms	
10Hz-100Hz	1(10Hz)	Ten period 980 to 1020 ms	

*Adjusted earlier in this step.

6.7.6 DISTORTION.

FREQUENCY range 100 Hz - 1 kHz
 FREQUENCY dial 2 (200 Hz)
 OUTPUT switch 5 V
 OUTPUT control fully cw

200 Hz. Disconnect the counter from the OUTPUT terminals and connect the wave analyzer and the 600- Ω load resistor in its place. Measure the second-

and third-harmonic distortion (400 Hz and 600 Hz); total distortion must be less than 0.05%.

$$\text{Total distortion} = \sqrt{(\text{second-harmonic distortion})^2 + (\text{third-harmonic distortion})^2}$$

10 kHz. Change the FREQUENCY range to 10 kHz - 100 kHz (10 kHz) and measure the second- and third-harmonic distortion (20 kHz and 30 kHz); total distortion must be less than 0.05%.

100 kHz. Change the FREQUENCY dial setting to 10 (100 kHz) and measure the second- and third-harmonic distortion (200 kHz and 300 kHz); total distortion must be less than 0.25%.

10 Hz. Change the FREQUENCY range to 10 Hz - 100 Hz and the FREQUENCY dial to 1 (10 Hz). Measure the second- and third-harmonic distortion (20 Hz and 30 Hz); total harmonic distortion must be less than 0.25%.

These measurements may also be made with a distortion meter.

6.7.7 HUM.

FREQUENCY range 1 kHz - 10 kHz
 FREQUENCY dial 1 (1 kHz)
 OUTPUT switch 500 mV
 OUTPUT control fully cw

Open circuit hum. Keep the wave analyzer connected to the OUTPUT terminals and measure the hum at 60, 120, and 180 Hz; total hum must be less than 0.01%.

$$\text{total hum} = \sqrt{(\text{hum at 60 Hz})^2 + (\text{hum at 120 Hz})^2 + (\text{hum at 180 Hz})^2}$$

6.7.8 SYNCHRONIZATION.

FREQUENCY range 100 Hz - 1 kHz
 FREQUENCY dial 10 (1 kHz)
 OUTPUT switch 5 V
 OUTPUT control fully cw

Sync in. Disconnect the wave analyzer from the OUTPUT terminals and connect a counter in its place. Connect the output of another oscillator (test



oscillator) to the EXT SYNC jack and set the test oscillator for 1V, rms, of exactly 1 kHz.

Very slowly increase the FREQUENCY dial setting of the Type 1309 until it drops out of sync (counter reading changes from 1 kHz to some higher frequency). Reduce the output amplitude of the test oscillator to below 50mV, rms, or turn its power switch off and note the counter reading (free-running frequency of the Type 1309); must be greater than 1030 Hz (1 kHz $\pm 3\%$).

Sync out. Disconnect the test oscillator from the EXT SYNC jack and connect the voltmeter in its place. The sync out amplitude should be approx 1.5 V rms.

6.7.9 OUTPUT RESPONSE.

Connect the 600-ohm load resistor and the voltmeter to the OUTPUT terminals and check as follows:

FREQUENCY		Output Voltage, rms
Range Setting	Dial Setting	
100Hz-1kHz	10 (1kHz)	Set OUTPUT controls for exactly 2.5V
100Hz-1kHz	5 (500Hz)	2.55 to 2.4V
100Hz-1kHz	1 (100Hz)	2.55 to 2.4V
10Hz-100Hz	1 (10Hz)	2.55 to 2.4V
1kHz-10kHz	10 (10kHz)	2.55 to 2.4V
10kHz-100kHz	10 (100kHz)	2.55 to 2.4V

6.7.10 CALIBRATION PROCEDURE FOR SQUARE-WAVE OUTPUT.

SYMMETRY.

FREQUENCY range 10 Hz - 100 Hz

FREQUENCY dial 10

OUTPUT switch \square 5 V p-p

OUTPUT control cw

Adjustment of R503. Connect the 50- Ω load resistor and the wave analyzer to the output of the Type 1309. Measure the second harmonic component (2 kHz) of the square wave. Adjust R503 (Figure 6-3) to minimize this component.

SQUARE-WAVE CHECKS.

Rise time adjustment.

FREQUENCY range 10 kHz - 100 kHz
 FREQUENCY dial 10
 OUTPUT switch \square 5 V p-p
 OUTPUT control cw

With the oscilloscope observe the output of the Type 1309 into the 50- Ω load resistor. Set the scope controls as follows:

Dual trace operation (MODE) one channel only
 Volts/div 0.1 V
 Time/div 10 μ s

Adjust C302 (Figure 6-3) for minimum overshoot and fastest rise time on the leading edge. There should be no noticeable ringing.

Measure the rise time of the square wave. It should be less than 100 μ s.

Output Amplitude. Remove the 50- Ω load resistor and measure the unloaded square-wave output. It should be at least 5 volts peak-to-peak.

Droop.

FREQUENCY range 10 Hz to 100 Hz
 FREQUENCY dial 1

Observe the square wave on the oscilloscope. There should be no measurable droop or ramp-off.

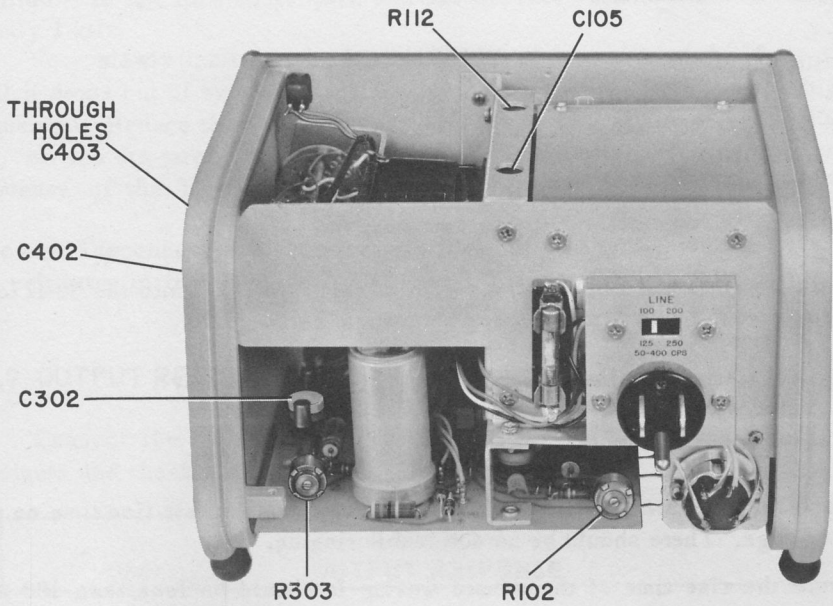

Figure 6-2. Top interior view of the Type 1309-A Oscillator.

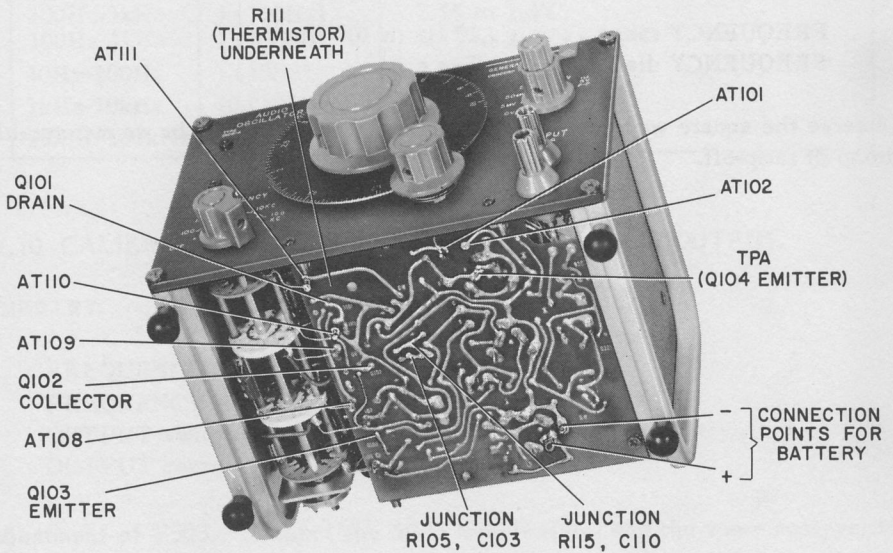

Figure 6-3. Bottom interior view.

PARTS LIST

REF NO.	DESCRIPTION	PART NO.
CAPACITORS		
C101	Electrolytic, 15 μ F +100-10% 15V	4450-3700
C102	Electrolytic, 15 μ F +100-10% 15V	4450-3700
C103	Electrolytic, 15 μ F +100-10% 15V	4450-3700
C104	Electrolytic, 10 μ F +100-10% 25V	4450-3800
C105	Trimmer, 5-25pF	4910-1150
C106	Mica, 62pF \pm 5%	4700-0364
C107	Ceramic, 0.1 μ F 50V	4403-4100
C108	Electrolytic, 200 μ F +100-10% 6V	4450-2610
C109A	Electrolytic, 300 μ F	
C109B	Electrolytic, 300 μ F 35V	4450-2400
C110	Electrolytic, 15 μ F +100-10% 15V	4450-3700
C111	Ceramic, 470pF \pm 10%	4404-1478
C301	Electrolytic, 10 μ F +100-10% 25V	4450-3800
C302	Trimmer, 8-50pF	4910-1170
C401A,B	Variable, Air, 630pF FREQUENCY	1210-4000
C402	Trimmer, 5.5-18pF	4910-2041
C403	Trimmer, 5.5-18pF	4910-2041
C404	Mica, 39pF \pm 5%	4640-0200
C405	Ceramic, 1.2pF \pm 5%	4400-0120
C501A	Electrolytic, 200 μ F	
C501B	Electrolytic, 200 μ F 50V	4450-5591
C502A	Electrolytic, 300 μ F	
C502B	Electrolytic, 300 μ F 35V	4450-2400
DIODES		
CR301	High-speed, Type 1N625	6082-1012
CR302	Zener, Type 1N971B	6083-1049
CR303	High-speed, Type 1N625	6082-1012
CR501	Rectifier, Type 1N3253	6081-1001
CR502	Rectifier, Type 1N3253	6081-1001
CR503	Zener, Type 1N973B	6083-1036
MISCELLANEOUS		
F501	FUSE, 0.125A 3AG, Slo-Blo	5330-0450
J201	JACK, Jack-top, binding post, OUTPUT	0938-3000
J202	JACK, Jack-top, binding post, Ground	0938-3000
J401	JACK, Phone jack, two contact, EXT SYNC	4260-1260
P501	PILOT LIGHT, 6V, 200mA	5600-1001
PL501	PLUG, 3-terminal, power	4240-0600
Q101	TRANSISTOR, Type U-147, field effect	8210-1090
Q102	TRANSISTOR, Type 2N3905	8210-1114
Q103	TRANSISTOR, Type 2N2714	8210-1047
Q104	TRANSISTOR, Type 2N697	8210-1040
Q301	TRANSISTOR, Type 2N3905	8210-1114
Q302	TRANSISTOR, Type 2N3905	8210-1114
Q501	TRANSISTOR, Type 2N697	8210-1040
S201	SWITCH, 6-position rotary, OUTPUT	7890-4210
S401	SWITCH, 6-position rotary, FREQUENCY	7890-4200
S501	SWITCH, power OFF part of S201	
S502	SWITCH, slide, LINE	7910-0831
T501	TRANSFORMER, Power	0745-4380

PARTS LIST (cont)

REF NO.	DESCRIPTION	PART NO.
RESISTORS		
R101	Composition, 22k Ω \pm 5% 1/2w	6100-3225
R102	Potentiometer, composition, 25k Ω \pm 20% (BIAS)	6040-0800
R103	Composition, 10k Ω \pm 5% 1/2w	6100-3105
R104	Composition, 12k Ω \pm 5% 1/2w	6100-3125
R105	Composition, 47k Ω \pm 5% 1/2w	6100-3475
R106	Composition, 51k Ω \pm 5% 1/2w	6100-3515
R107	Composition, 27k Ω \pm 5% 1/2w	6100-3275
R108	Composition, 3.3k Ω \pm 5% 1/2w	6100-2335
R109	Composition, 15k Ω \pm 5% 1/2w	6100-3155
R110	Composition, 560 Ω \pm 5% 1/2w	6100-1565
R111	Thermistor	6741-2023
R112	Potentiometer, composition, 500 Ω \pm 20%	6040-0300
R113	Composition, 10k Ω \pm 5% 1/2w	6100-3105
R114	Composition, 270 Ω \pm 5% 1/2w	6100-1275
R115	Composition, 5.6k Ω \pm 5% 1/2w	6100-2565
R116	Composition, 1k Ω \pm 5% 1/2w	6100-2105
R117	Composition, 100 Ω \pm 5% 1/2w	6100-1105
R118	Composition, 2.4k Ω \pm 5% 1/2w	6100-2245
R119	Composition, 510 Ω \pm 5% 1/2w	6100-1515
R201	Film, 665 Ω \pm 1% 1/2w	6450-0665
R202	Film, 6.65k Ω \pm 1% 1/2w	6450-1665
R203	Film, 66.5k Ω \pm 1% 1/2w	6450-2665
R204	Film, 604k Ω \pm 1% 1/2w	6450-3604
R205A,B	Potentiometer, composition, (OUTPUT control)	6045-1100
R206	Composition, 620 Ω \pm 5% 1/2w	6100-1625
R207	Composition, 620 Ω \pm 5% 1/2w	6100-1625
R208	Composition, 36 Ω \pm 5% 1/2w	6100-0365
R301	Composition, 1.2k Ω \pm 5% 1/2w	6100-2125
R302	Composition, 15k Ω \pm 5% 1/2w	6100-3155
R303	Potentiometer, composition, 2.5k Ω \pm 20% (SYMMETRY)	6040-0500
R304	Composition, 10k Ω \pm 5% 1/2w	6100-3105
R305	Composition, 22k Ω \pm 5% 1/2w	6100-3225
R306	Composition, 620 Ω \pm 5% 1/2w	6100-1625
R307	Composition, 2.0k Ω \pm 5% 1/2w	6100-2205
R308	Composition, 100 Ω \pm 5% 1/2w	6100-1105
R309	Composition, 11k Ω \pm 5% 1/2w	6100-3115
R310	Composition, 4.7k Ω \pm 5% 1/2w	6100-2475
R401	Film, 26.7M Ω \pm 1% 1w	6550-5267
R402	Film, 26.7M Ω \pm 1% 1w	6550-5267
R403	Film, 2.67M Ω \pm 1% 1/2w	6450-4267
R404	Film, 2.67M Ω \pm 1% 1/2w	6450-4267
R405	Film, 267k Ω \pm 1% 1/2w	6450-3267
R406	Film, 267k Ω \pm 1% 1/2w	6450-3267
R407	Film, 26.7k Ω \pm 1% 1/2w	6450-2267
R408	Film, 26.7k Ω \pm 1% 1/2w	6450-2267
R501	Composition, 47 Ω \pm 5% 1w	6110-0475
R502	Composition, 2.7k Ω \pm 5% 1/2w	6100-2275

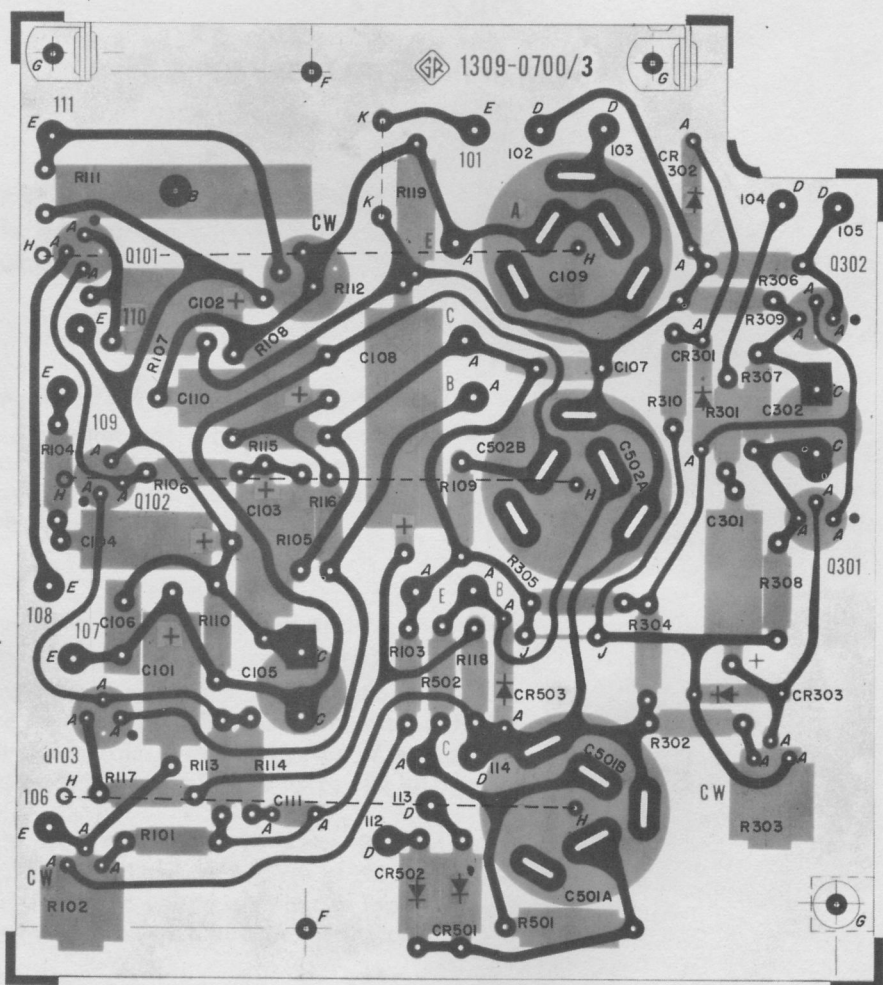
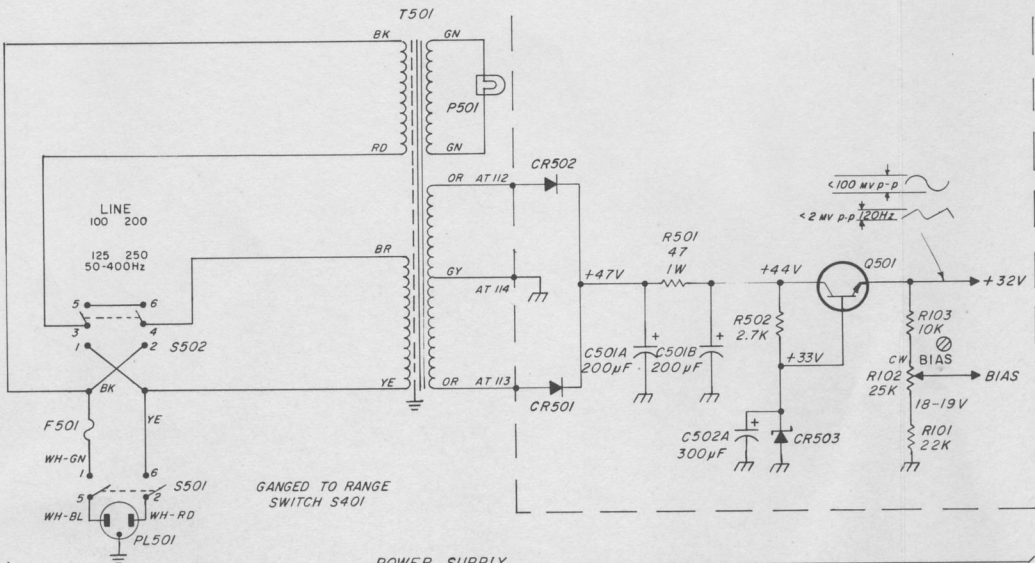
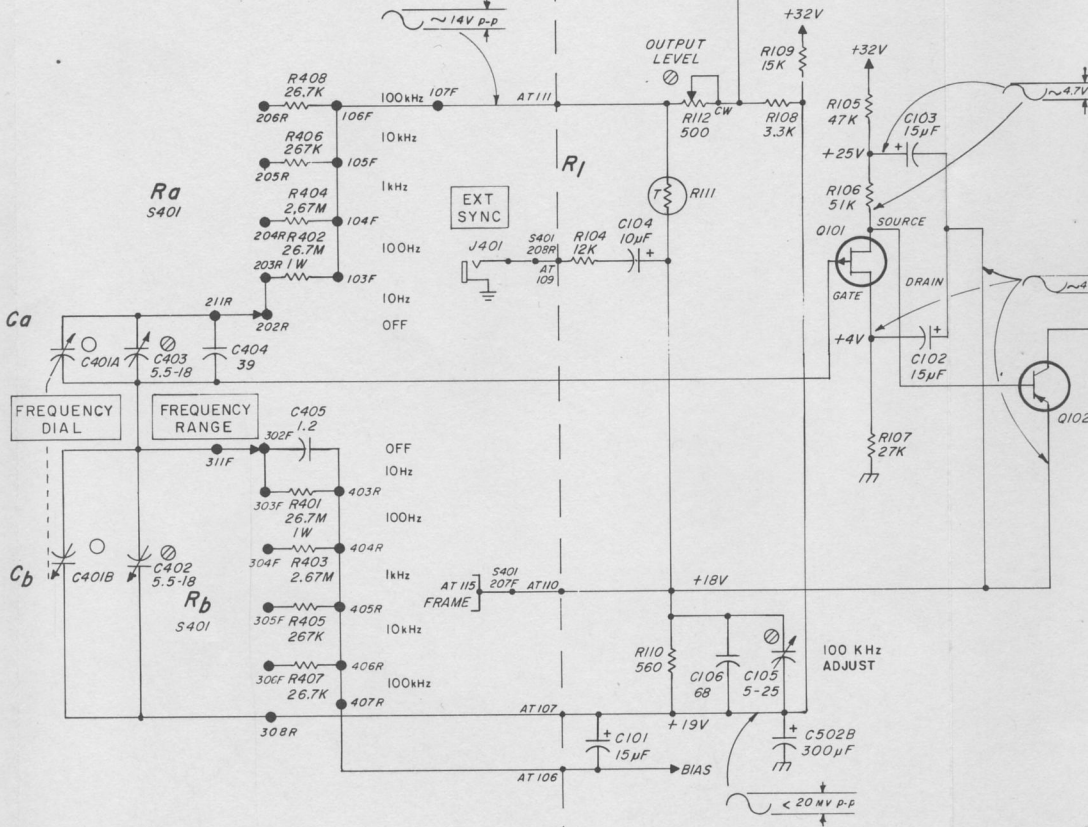
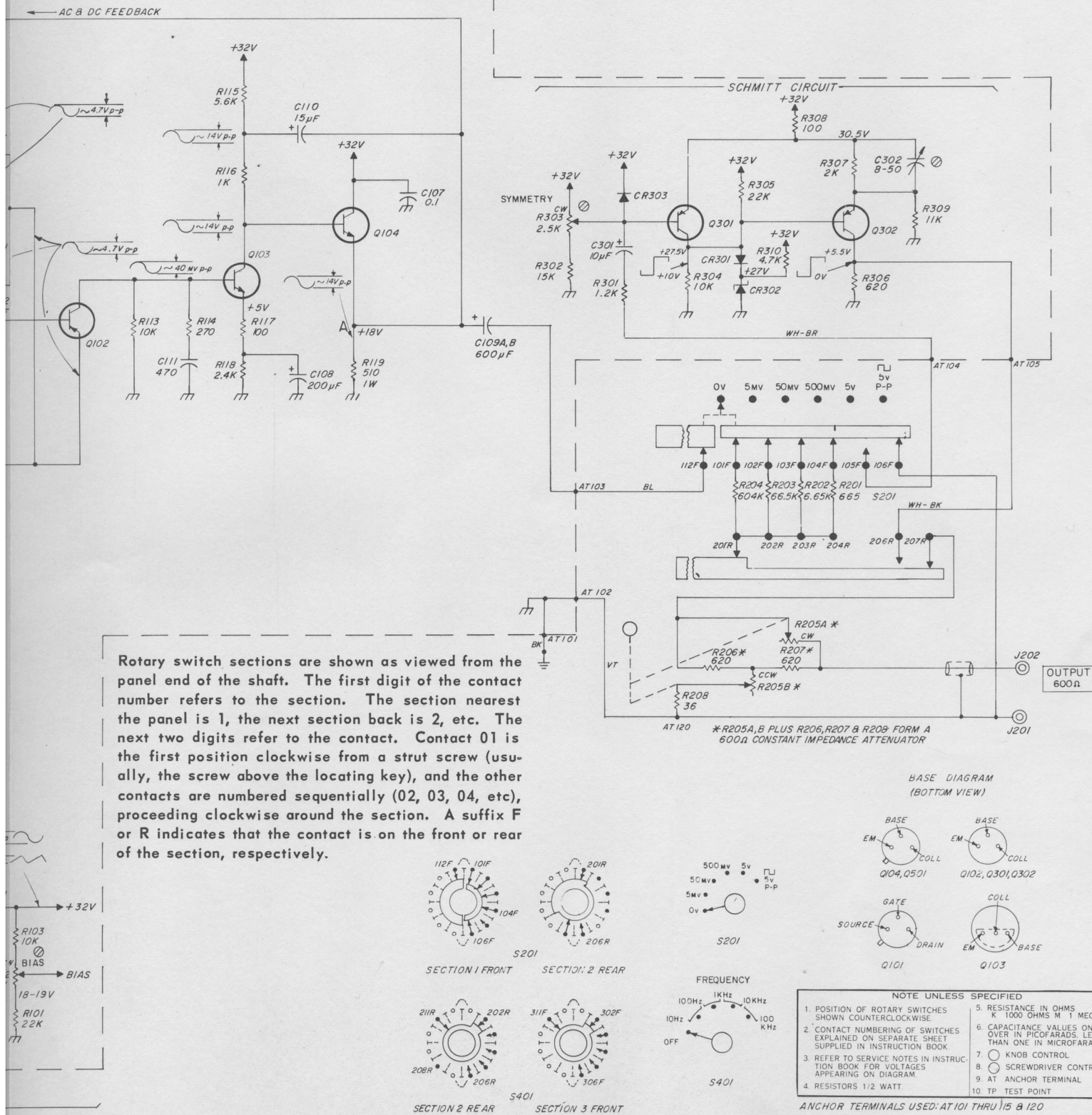

Figure 6-4. Etched-board assembly of the Type 1309-A Oscillator.

NOTE: The number appearing on the etched board is the number of the board only, without circuit components. When ordering a new etched-board assembly, use the following part number: 1309-2700.

← AC B DC F





APPENDIX

SUPPLEMENTARY EQUIPMENT AVAILABLE.

Type 480-P308 Relay Rack Adaptor Set

This adaptor set allows the oscillator to be mounted in a standard 19-inch relay-rack.



Type 480-P316 Relay-Rack Adaptor Set

This adaptor set allows the oscillator to be mounted side-by-side with another 8 x 5¼-inch, convertible-bench instrument in a standard 19-inch relay rack.



Type 1396 Tone Burst Generator.

This instrument allows the output of the oscillator to be gated on and off coherently. The gate-on and gate-off times are independently adjustable from 2 to 128 cycles of any output frequency of the oscillator up to 100 kHz.



With the Type 480-P316 Relay-Rack Adaptor Set, listed above, the Type 1396 and Type 1309-A can be bolted together to form a single unit for either bench or rack installation.

Type 1232 Tuned Amplifier and Null Detector.

This instrument, with the oscillator, forms a detector-oscillator assembly with a sensitivity of 0.1 μV and a frequency range of 20 Hz to 20 kHz, plus two fixed frequencies of 50 and 100 kHz.

With the Type 480-P316 Relay-Rack Adaptor Set listed above, the Type 1232 and oscillator can be bolted together to form a single unit for either bench or rack installation.



GENERAL RADIO COMPANY

WEST CONCORD, MASSACHUSETTS 01781

617 369-4400

617 646-7400

SALES ENGINEERING OFFICES

NEW ENGLAND *

22 Baker Avenue
West Concord, Massachusetts 01781
Telephone 617 646-0550

METROPOLITAN NEW YORK *

Broad Avenue at Linden
Ridgefield, New Jersey 07657
Telephone N.Y. 212 964-2722
N.J. 201 943-3140

SYRACUSE

Pickard Building
East Molloy Road
Syracuse, New York 13211
Telephone 315 454-9323

PHILADELPHIA

Fort Washington Industrial Park
Fort Washington, Pennsylvania 19034
Telephone 215 646-8030

WASHINGTON * AND BALTIMORE

11420 Rockville Pike
Rockville, Maryland 20852
Telephone 301 946-1600

ORLANDO

113 East Colonial Drive
Orlando, Florida 32801
Telephone 305 425-4671

* Repair services are available
at these district offices.

CHICAGO *

6605 West North Avenue
Oak Park, Illinois 60302
Telephone 312 848-9400

CLEVELAND

5579 Pearl Road
Cleveland, Ohio 44129
Telephone 216 886-0150

LOS ANGELES *

1000 North Seward Street
Los Angeles, California 90038
Telephone 213 469-6201

SAN FRANCISCO

626 San Antonio Road
Mountain View, California 94040
Telephone 415 948-8233

DALLAS *

2600 Stemmons Freeway, Suite 210
Dallas, Texas 75207
Telephone 214 637-2240

TORONTO *

99 Floral Parkway
Toronto 15, Ontario, Canada
Telephone 416 247-2171

MONTREAL

1255 Laird Boulevard
Town of Mount Royal, Quebec, Canada
Telephone 514 737-3673

General Radio Company (Overseas), 8008 Zurich, Switzerland
General Radio Company (U.K.) Limited, Bourne End, Buckinghamshire, England
Representatives in Principal Overseas Countries